

CEM-190-10

CEM-196-10

(Complete with GSM/GPRS – UMTS – LTE module)

Controls and commands an engine driven irrigation pump. It includes water pressure transmitter with digital pressure gauge. Enables manual or automatic adjustment of the engine rpm and stopping if a fault occurs. It is possible to request the model with incorporated emergency button installed on the front panel (CEM-190EM or CEM-196EM).



USER'S MANUAL



Tel. +39 0521/772021 Fax +39 0521/270218
E-mail: info@elcos.it - <https://www.elcos.it>



CONTENTS

CONTROL UNIT FOR COMMAND AND PROTECTION OF ENGINE DRIVEN IRRIGATION PUMP.....	1
CONTENTS	2
CHRONOLOGY OF MANUAL REVISIONS	4
INSTRUCTIONS IN BRIEF	5
GENERAL DESCRIPTION	6
TYPES	6
LIST OF PROTECTIONS	6
INSTRUMENTS	6
NAVIGATING ACROSS INSTRUMENTS	6
MAIN DASHBOARD	7
COMMANDS	7
INDICATORS	7
STATUSES	7
INDICATOR LIGHTS	7
DASHBOARD ADJUSTMENT	8
DASHBOARD PUMP	9
SYSTEM STATUS	9
PROTECTION TIMER	9
WORKING PRESSURE	9
PRESSURE LIMITS	9
PRESSURE OK	9
OPERATION	9
SELECT/EDIT	9
DASHBOARD ENGINE	10
INDIVIDUAL INSTRUMENTS	10
DASHBOARD FAULT	10
DASHBOARD TIMER	11
DASHBOARD MESSAGES	11
ECU-EQUIPPED ENGINES	11
ECU READINGS	12
TERMINATION RESISTOR	12
FAULT CODES ACTIVE	13
FPT STAGE V ENGINES	13
CONNECTIONS	13
SIGNALLING LAMPS	14
MANAGEMENT OF EMISSIONS REDUCTION DEVICES	14
REGENERATION	14
OIL COUNTER RESET	15
DOOSAN STAGE V ENGINES	16
CONNECTIONS	16
SIGNALLING LAMPS	16
MANAGEMENT OF EMISSIONS REDUCTION DEVICES	16
REGENERATION	16
DEUTZ STAGE V ENGINES	18
CONNECTIONS	18
SIGNALLING LAMPS	18
MANAGEMENT OF EMISSIONS REDUCTION DEVICES	18
REGENERATION	18
OPERATION	19
START_STOP_BUTTON	19
ACCELERATE_BUTTON AND DECELERATE_BUTTON	19
UP_BUTTON, DOWN_BUTTON, LEFT_BUTTON AND RIGHT_BUTTON	19
START/STOP	20
DECELERATION	20
COOLING	20

MANUAL IRRIGATION MODE	20
AUTOMATIC IRRIGATION MODE	20
PRESSURE	20
SPEED	21
COMBINED	21
ADJUSTMENT.....	21
IRRIGATION OFF MODE	22
TABLE OF IRRIGATION MODES AND SETTINGS	22
DISPENSED WATER	23
LITERS COUNTER	23
PRESSURE	24
START AND STOP FLOAT SWITCHES	24
FILLING	24
EMPTYING	25
ENGINE PROTECTIONS	25
ACTIVATION.....	25
PROTECTIONS.....	25
PUMP PROTECTIONS	25
ENABLING	25
PUMP PROTECTION DISABLE BUTTON.....	25
WATER PRESSURE TRANSM.	25
Water pump maximum pressure	26
MINIMUM PRESSURE	26
Water pump pressure transmitter fault	26
OVERPRESSURE AND UNDERPRESSURE	26
PUMP PRESSURE SWITCH.....	27
FILTER WASHING	27
CAVITATION.....	27
RESET	28
EMERGENCY STOP	28
MODEM COMMANDS (CEM-196-10)	28
PROCEDURE TO DISABLE THE PIN	28
COMMISSIONING	28
SMS.....	28
FAULT NOTIFICATION	28
START AND STOP NOTIFICATION CALENDAR	28
END OF WORK NOTIFICATION	28
SMS COMMANDS	28
FUEL FAULT	29
APP	30
EVENT LOG	30
POWER SAVING	32
WAKE UP	32
INSTALLATION	32
STOPPING SYSTEMS	32
GLOW PLUGS	32
GENERAL ALARM	32
ENGINE RUNNING DETECTION	32
TACHOMETER CALIBRATION	33
CLUTCH	33
ENGINE WARM-UP	33
PUMP PRIMING	33
PIPE FILLING	34
OPERATING MODE	37
MAINTENANCE	37
START-UP	38
PROGRAMMABLE INPUTS	38
PROGRAMMABLE OUTPUTS	38
FAULTS.....	39
< Water pump pressure transmitter fault>	41
SERIAL PORTS	42
CONNECTION DIAGRAM.....	42

CONNECTOR PINOUTS.....	47
SETTINGS	49
SETTING TYPES	49
MULTIPLE CHOICE	49
PASSWORD.....	49
CLOCK/CALENDAR	50
EXCLUSION	50
VALUE	50
TEXT STRING SETTINGS.....	50
TABLE SETTINGS	51
TIME	51
CONFIRM ACTION.....	51
SPECIAL CASES.....	51
SETTINGS SW	51
PARAMETER SETTINGS	52
LANGUAGE CHOICE	52
DATA.....	52
CALENDAR CLOCK.....	52
BATTERY	53
ENGINE	53
ENGINE TRANSDUCERS	55
ENGINE ECU.....	56
IRRIGATION	57
ENGINE RPM MANAGEMENT	58
CONTROL.....	58
PUMP PRIMING	59
PIPE FILLING.....	59
CLUTCH.....	59
MODEM.....	59
IN-OUT.....	60
PROGRAMMABLE INPUTS	60
PROGRAMMABLE OUTPUTS.....	61
SERIAL PORTS	62
DEVICE	62
HISTORY.....	62
MAINTENANCE	63
SERVICE (electronic engines only).....	63
REPLACING THE CONTROL UNIT.....	63
TROUBLESHOOTING	64
TECHNICAL SPECIFICATIONS.....	65
MECHANICAL DIMENSIONS.....	66
INSERTING THE SIM CARD CEM-196-10	68
WARNING	69
INFORMATION FOR ORDERING	70
STANDARD ACCESSORIES	70
ACCESSORIES AVAILABLE ON REQUEST.....	70
ON-LINE LITERATURE.....	70

CHRONOLOGY OF MANUAL REVISIONS			
Date	Revision	Description	Page
18/02/2022	1.00	First release	
13/09/2022	2.00	Updates regarding automatic pressure adjustment (as CIM-13x)	
07/12/2022	3.00	Added management of electronic motors and pump cavitation. Functions valid from firmware release 3.00	
08/03/2023	3.01	Doosan engine and connections table	
09/06/2023	3.02	Updated with firmware 3.14 release	
25/07/2023	3.03	Updated with firmware 3.15/3.16 release	
13/10/2023	3.04	Deutz Stage V a Added.management motors. Updated with firmware 3.17. R termination. CAN.	

INSTRUCTIONS IN BRIEF

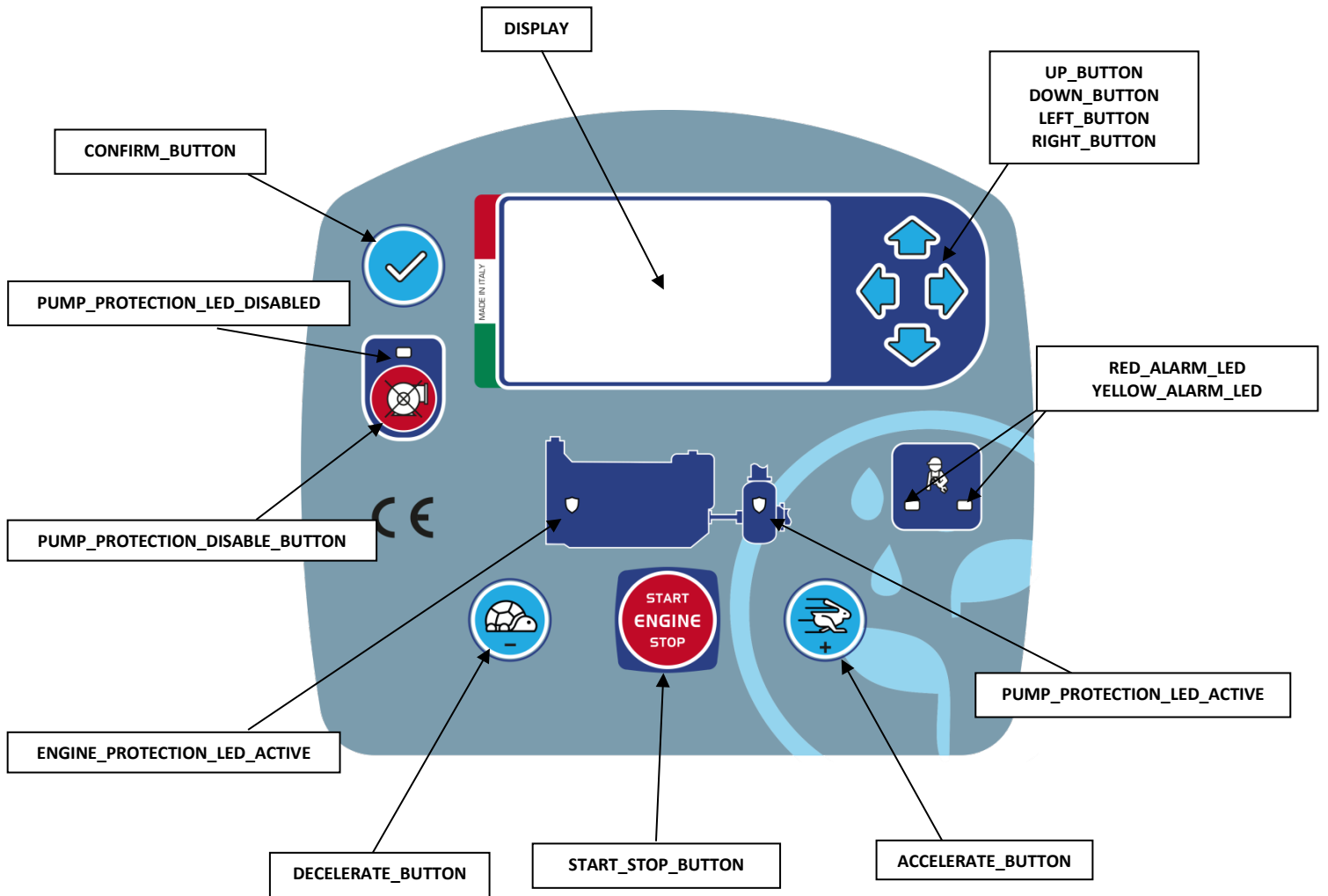

CONFIRM_BUTTON

Confirms the action.

PUMP_PROTECTION_LED_DISABLED

It flashes when pump protections are disabled

PUMP_PROTECTION_DISABLE_BUTTON

Press until LED starts to flash to disable pump protections. To re-enable, press again until the LED turns off.

ENGINE_PROTECTION_LED_ACTIVE

ON if engine protections are active.

DECELERATE_BUTTON, ACCELERATE_BUTTON

Decelerates/accelerates the engine. When the control unit is on, the buttons are always active, even when the engine is not running.

START_STOP_BUTTON

If the control unit is switched off, press the button for at least one second; the control unit will switch on, performing an LED test and checking for any faults.

Starts/stops the engine when the control unit is on.

PUMP_PROTECTION_LED_ACTIVE

ON if pump protections are active.

RED_ALARM_LED

It flashes if a fault has stopped the engine. In electronic engines, steadily lit indicates an active RED STOP fault in the engine ECU.

YELLOW_ALARM_LED

It flashes if there is a warning fault that does not stop the engine. In electronic engines, steadily lit indicates an active AMBER WARNING fault in the engine ECU.

UP_BUTTON, DOWN_BUTTON, LEFT_BUTTON, RIGHT_BUTTON

Press the arrows to browse display menus.

Acknowledging the general alarm.

GENERAL DESCRIPTION

The control unit allows starting and stopping an engine-driven irrigation pump. It can manage a linear actuator used to vary the diesel engine's rpm. With each rpm variation there is a variation in irrigation pressure.

The operator can choose either to work with an automatic system that adjusts the working pressure to the preset value and maintains it until the irrigation cycle ends, or to work in manual mode by accelerating or decelerating the engine using the buttons on the front of the control unit. In either case, all diesel engine and pump protections will be managed.

The CEM-196-10 model manages the remote control with modem via app or SMS text message.

The start and stop can also be triggered via external contact.

If necessary, pump protections can be disabled temporarily by simply operating the button on the front panel. It is also possible to set an operation timer that stops the pump when the time expires.

Functions can be managed easily thanks to the messages displayed. Pop-up messages highlight statuses in progress, showing any times about to expire or indicating which buttons to press; they also display, in text form, any triggered faults or pre-alarms that could stop the engine.

TYPES

The following table summarises the differences between the various models available:

TYPE	MODEM 4G	INCORPORATED EMERGENCY BUTTON
CEM-190-10	NO	NO
CEM-196-10	YES	NO
CEM-190EM	NO	YES
CEM-196EM	YES	YES

LIST OF PROTECTIONS

The control unit protects the pump by stopping the engine if a fault occurs.

List of engine protections or alarms	List of pump protections
<ul style="list-style-type: none"> Low oil pressure (from contact and/or transmitter) Engine overtemperature (from contact and/or transmitter) Alternator belt breakage Fuel reserve No fuel (from contact and/or transmitter) Low fuel pressure Low coolant level Battery voltage low Battery voltage high Underspeed (disabled at the factory) Overspeed (disabled at the factory) Emergency button 	<ul style="list-style-type: none"> Pump water low pressure Pump water high pressure Maximum pump water pressure Pump water transmitter fault

INSTRUMENTS

The control unit has a backlit 240 x 128 dot graphic display. It displays instruments and provides access to parameter setting.

NAVIGATING ACROSS INSTRUMENTS

The instruments displayed on the control unit are divided into pages, each with a uniform group of instruments; to move from one page to another, use the RIGHT_BUTTON and LEFT_BUTTON; to move within the pages, use the UP_BUTTON and DOWN_BUTTON.

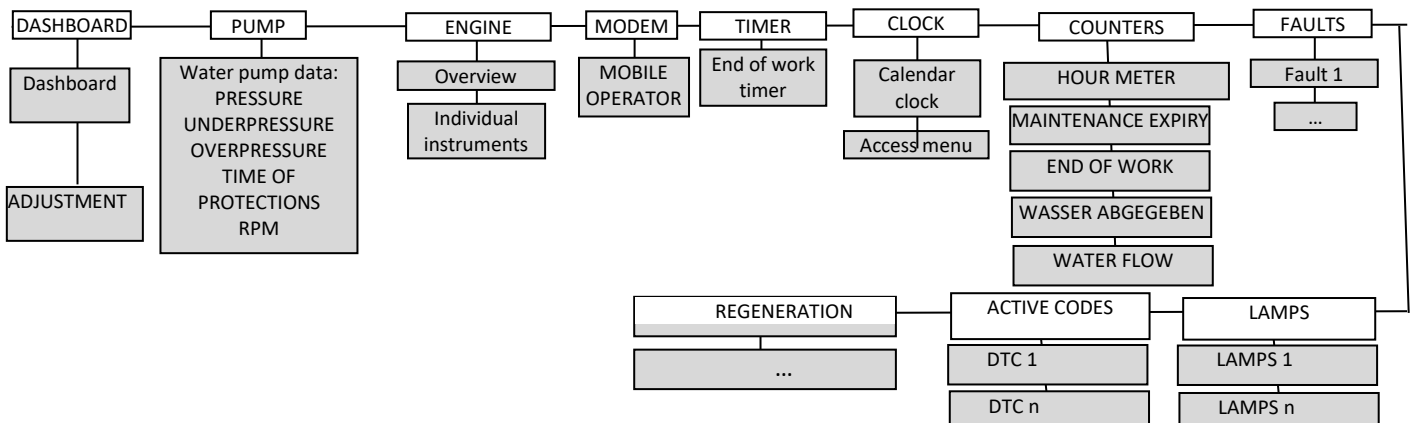

MAIN DASHBOARD

This is the most important instrument. It lets you provide commands and check the general status of the pump. An example is given below:

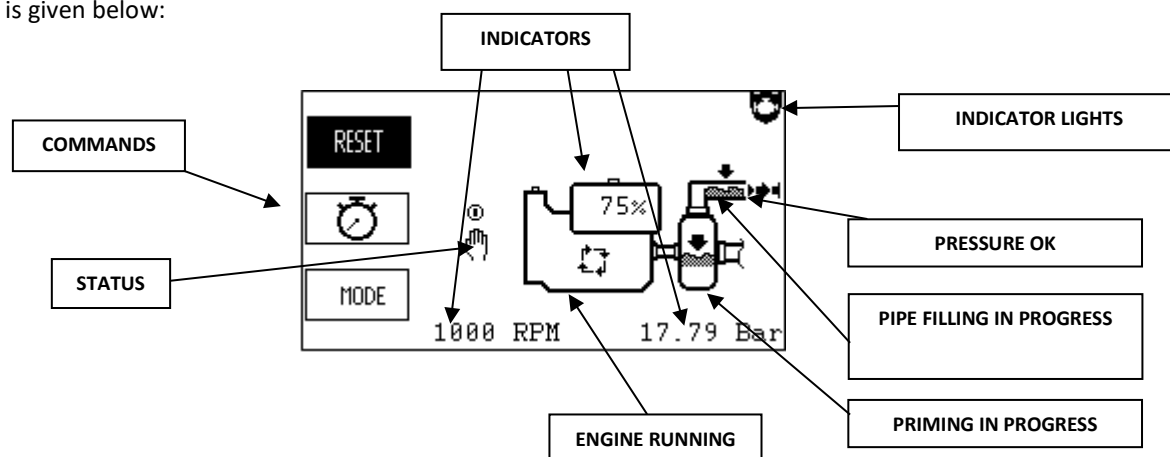

COMMANDS

The selected command is highlighted; to move from one command to the other, use the UP_BUTTON and DOWN_BUTTON and the CONFIRM_BUTTON to execute the command. Available commands (if all enabled) are:

Symbol	Name	BRIEFLY
MODE	IRRIGATION MODE	Sets the irrigation mode: MANUAL / OFF / AUTOMATIC.
RESET	RESET	Restores the control unit; see section on restoring.
	STOP TIMER	Sets up the stop timer
	SPOTLIGHT COMMAND	Controls the SPOTLIGHT function-output. To enable, see setting DEVICE > LIGHT CONTROL

INDICATORS

They display the machine's primary data:

- ENGINE RPM
- PUMP BAR
- FUEL TANK















STATUSES

Symbol	Meaning
	STOP TIMER
	FUNCTION-INPUT CALL ENABLED
	START BY FUNCTION-INPUT FLOAT START / FLOAT STOP
	MANUAL START
	STOP BY FUNCTION-INPUT FLOW SWITCH
	LOCK BY FUNCTION-INPUT LOCK
	LOCK BY LOCK MODE
	REMOTE START BY SMS TEXT OR APP
	END OF WORK

INDICATOR LIGHTS

Up to 10 indicator lights can be displayed simultaneously:

Symbol	Meaning
	TIMER ACTIVE
	ENGINE PROTECTIONS ACTIVE
	PUMP PROTECTIONS ACTIVE
	COOLING
	WARM-UP

	GLOW PLUGS
	FAULT CAUSES STOP
	FAULT ONLY WARNING
	MAINTENANCE EXPIRED
	FILTER WASH IN PROGRESS
	DECELERATION IN PROGRESS
	FUNCTION-OUTPUT LIGHT ACTIVE
	OFF MODE
	MANUAL MODE
	AUTOMATIC MODE
	CLUTCH ENABLED
	SIGNALLING SENT BY THE ENGINE ECU PRESENT IN THE TOOL LAMPS
	ACTIVE FAULT CODES DETECTED BY THE ENGINE ECU
	REGENERATION REQUESTED BY ENGINE ECU
	REGENERATION BLOCKED

If IRRIGATION > PUMP PROTECTION SENSOR = PUMP PRESSURE SWITCH, the instrument shows the time to pump protection activation, not the pump pressure value.

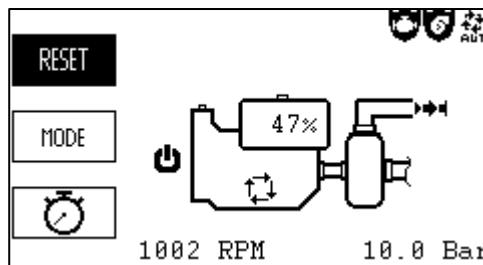

DASHBOARD ADJUSTMENT

The instrument is accessed from the MAIN DASHBOARD with a press of the UP_BUTTON when the virtual button MODE is selected. This is the instrument that shows the type of adjustment applied in AUT:

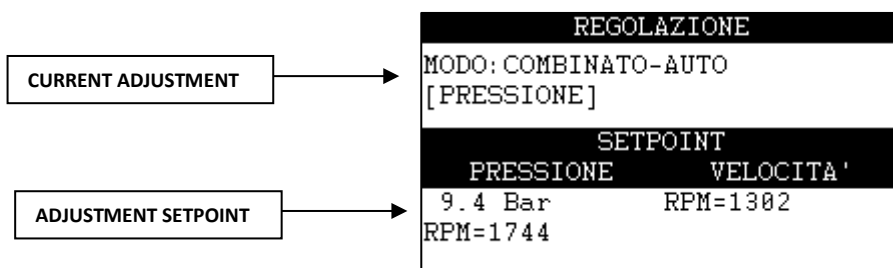

The example shows a combination adjustment mode, with auto-detect of the setpoint speed; the pressure control is activated (as per selection at inputs) and the pressure setpoints (including operating speed) and speed setpoints shown. In the event of Speed or Pressure mode (not combination mode), only one setpoint is shown.

DASHBOARD PUMP

This instrument displays the status of the water pump and allows changing the water pump underpressure and overpressure values. If IRRIGATION > PUMP PROTECTION SENSOR = PUMP PRESSURE SWITCH, the instrument is disabled. An example is given below:

An example is given below:

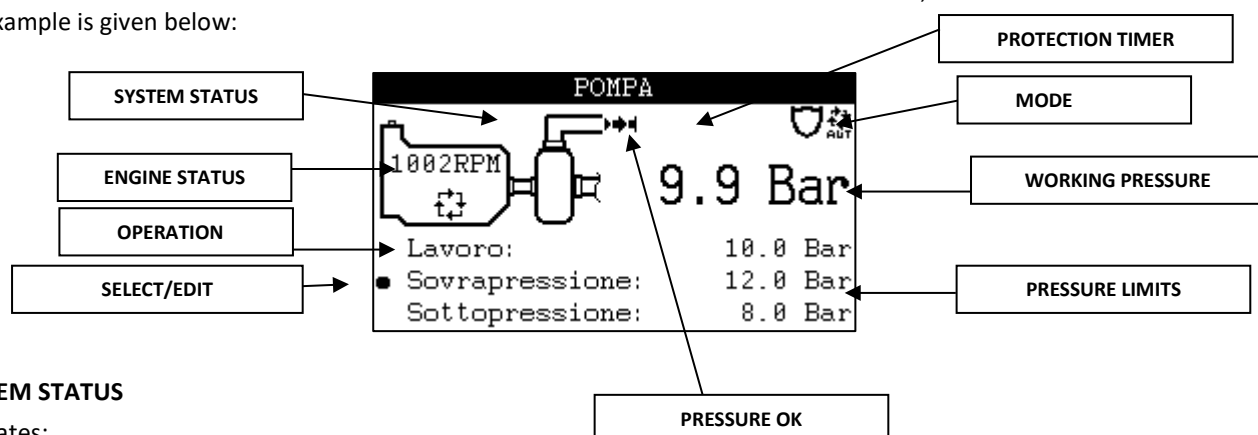

SYSTEM STATUS

Indicates:

- PUMP PRIMING IN PROGRESS
- PIPE FILLING IN PROGRESS
- ENGINE RPM
- ENGINE RUNNING

PROTECTION TIMER

Indicates time to activation of pump protections.

WORKING PRESSURE

Indicates the pump's operating pressure – WORKING PRESSURE.

- MODE = MAN Indicates the detected pressure when the protections are activated
- MODE = AUT Indicates the set working pressure

PRESSURE LIMITS

Indicates, once acquired, the pump's underpressure and overpressure values.

PRESSURE OK

The symbol is shown when the engine is running and:

- MODE = MAN The protections are active and the pressure is within the working range
The protections are not active and the pressure is within the maximum and minimum pressure range
- MODE = AUT An operating point was detected and the pressure is within the fluctuation range

OPERATION

Indicates how the control unit is operating and the detected rpm/pressure parameters.

SELECT/EDIT



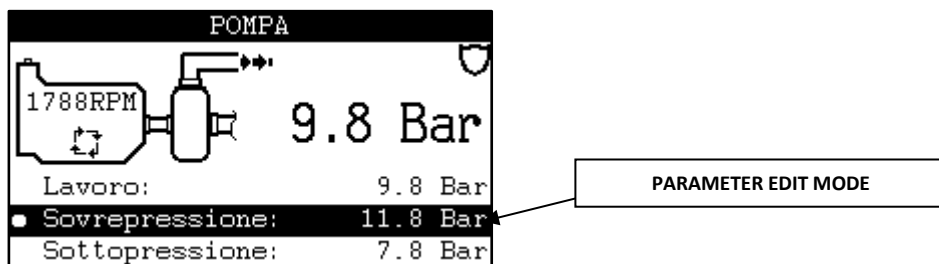

Used to select the parameter you want to edit: OVERPRESSURE or UNDERPRESSURE; to move, press UP_BUTTON or DOWN_BUTTON. To enter edit mode and change the value, press the CONFIRM_BUTTON when the desired parameter is selected:









When the item is in edit mode, use the UP_BUTTON and DOWN_BUTTON to change the value and the CONFIRM_BUTTON to confirm the new setting and return to display mode. After 1' of inactivity in edit mode, the unit will return to display mode automatically without changing the value.

DASHBOARD ENGINE

The first instrument of the group provides all the values for the diesel engine, as in the example below:

MOTORE			
	13.9 V		10.6 V
	2328 RPM		
	75 °C		
	49 psi		

Engine instruments are displayed individually or an overview is given:

Symbol	Parameter	Control Unit	UM
	BATTERY VOLTAGE	Voltmeter	V
	RPM	Alternator	RPM
	TEMPERATURE	Sensor	°C/°F
	OIL PRESSURE	Sensor	BAR/kPa/psi
	FUEL LEVEL	In Float switch	%
	ALTERNATOR CHARGE	Alternator	V

INDIVIDUAL INSTRUMENTS

Each engine value – pressures, temperatures, voltages, fuel, etc. – can be displayed in more detailed form.

Example: battery voltage:

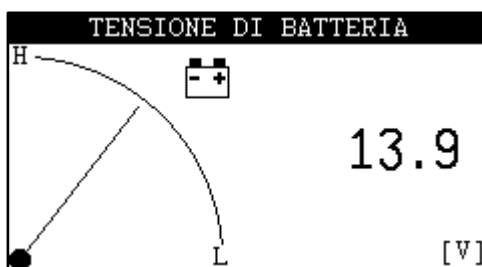

DASHBOARD FAULT

Use the UP_BUTTON and DOWN_BUTTON to select the displayed fault:

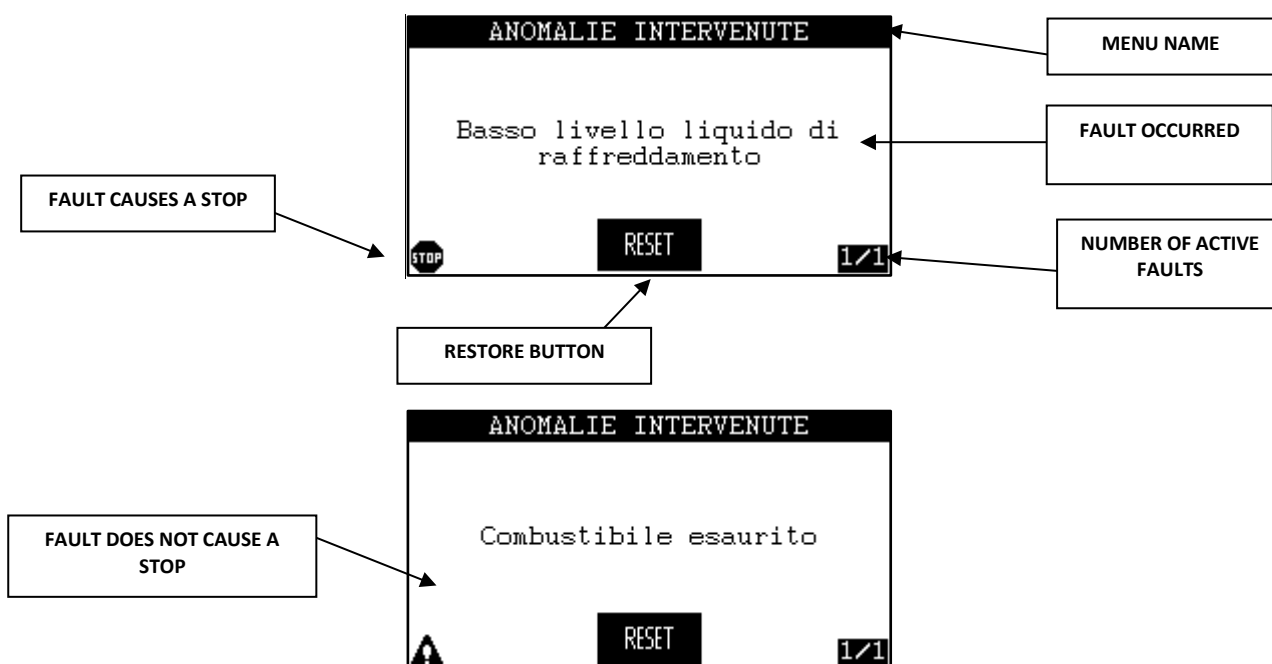

Pressing the CONFIRM_BUTTON will restore the device; press the Restore Button (virtual) on the display.

DASHBOARD TIMER

The timer is used to operate the pump for a preset time (if necessary), up to a maximum of 96 hours. At the end, the pump is stopped and the message Stop at work end by timer. is displayed.

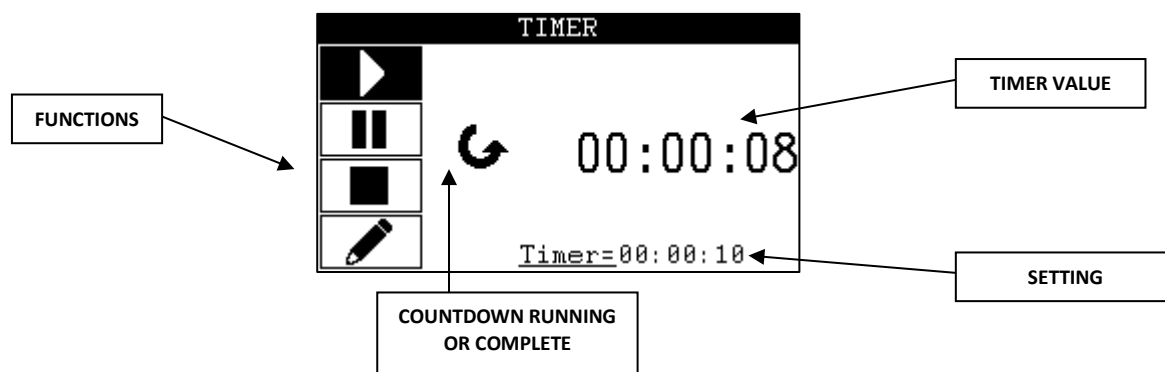

Use the UP_BUTTON and DOWN_BUTTON to change the selection of the function and the CONFIRM_BUTTON to confirm the selection:

Symbol	Meaning
	START: starts the countdown
	PAUSE: pauses the countdown
	STOP: interrupts the countdown and restores the value
	EDIT: edits the setting

DASHBOARD MESSAGES

In some cases, a message window can appear on top of the instruments. There are multiple types of messages and they are sequentially displayed every 5 seconds. Pressing the UP_BUTTON, DOWN_BUTTON, RIGHT_BUTTON or LEFT_BUTTON scrolls the sequence, at the end of which it cancels the window.

Example of message:

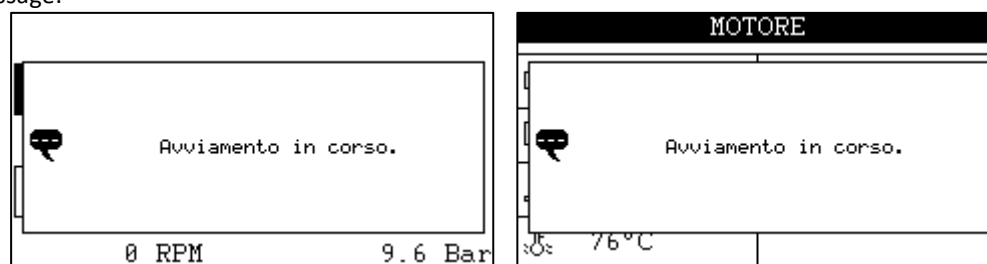

ECU-EQUIPPED ENGINES

When an ECU-equipped engine is used, the control unit dialogues with it in order to:

- Adjust the engine rpm
- Gather the values read (temperature, RPM, pressures, etc.)
- Gather active engine fault codes.

The control unit supports different types of engines, selected via the parameter in ENGINE ECU > ENGINE TYPE









ENGINE TYPE	DPF/SCR	SUPPORTED ENGINES
NO CAN BUS	-	Engines without engine ECU
SAE J1939 GENERIC	NO	Generic engine with ECU compliant with standard SAE J1939
JOHN DEERE	NO	JOHN DEERE 4000, 6000
PERKINS 110X/220X	NO	110X, 220X
SCANIA	NO	Scania Stage 3 variable speed engines
KOHLER	NO	
DEUTZ EMR2/EMR3	NO	Engines equipped with control units EMR2, EMR3
FPT NEF/CURSOR	NO	NEF45, NEF67, CURSOR
VM R756 IE3	NO	R756 IE3
YANMAR	NO	3NTV88F
HATZ	NO	3H50T
AIFO	NO	
JCB DIESEL MAX	NO	

FPT STAGE V	YES	FPT F34, F36, N45, N67 family engines
DOOSAN STAGE V	YES	Doosan D18, D24, D34 engines
DEUTZ STAGE V	YES	DEUTZ TD engines equipped with EMR4, EMR5 and EMR-L1 engine ECU





















ECU READINGS

If the ECU reads an instrument, it is indicated; in the example, the battery voltage and D+ voltage are read by the control unit. If an engine instrument is disabled in the ECU, it is not displayed.

If the following error is displayed in error, in the example the oil temperature:

MOTORE [1/2]			
	16.2 V		Err! ECU
	0 RPM ECU		40 °C ECU
	74 % ECU		35 °C ECU
	0.2 V		4.1 Bar ECU

The instrument can be disabled and greyed out even if the ECU returns a correct value. The summary table is provided below:

Symbol	Parameter	Source	UM
	RPM	ECU: spn 190	RPM
	TEMPERATURE	ECU: spn 110	°C/°F
	OIL PRESSURE	ECU: spn 100	BAR/Kpa
	FUEL LEVEL	ECU: spn 96	%
	OIL TEMPERATURE	ECU: spn 175	°C/°F
	INTAKE TEMPERATURE	ECU: spn 105	°C/°F
	TURBO TEMPERATURE	ECU: spn 176	°C/°F
	FUEL PRESSURE	ECU: spn 94	BAR/Kpa
	COOLANT PRESSURE	ECU: spn 109	BAR/Kpa
	INSTANT CONSUMPTION	ECU: spn 183	l/h
	FUEL TEMPERATURE	ECU: spn 174	°C/°F
	ENGINE TORQUE	ECU: spn 513	%
	ENGINE LOAD	ECU: spn 92	%
	INTERCOOLER TEMPERATURE	ECU: spn 52	°C/°F
	COOLANT LEVEL	ECU: spn 111	%
	OIL LEVEL	ECU: spn 98	%
	SOOT LEVEL	ECU: spn 3719	%
	ASH LEVEL	ECU: spn 3720	%
	REAGENT LEVEL	ECU: spn 1761	%
	REAGENT TEMPERATURE	ECU: spn 3031	°C/°F

TERMINATION RESISTOR

The line termination resistor is inserted by default.

FAULT CODES ACTIVE

The ACTIVE CODES instrument group shows faults detected by the engine's ECU. The LEDs do not flash but are steady-on, in line with the RED STOP and AMBER WARNING signals of the DM1 message. Some ECU faults are translated. The representation is as follows:

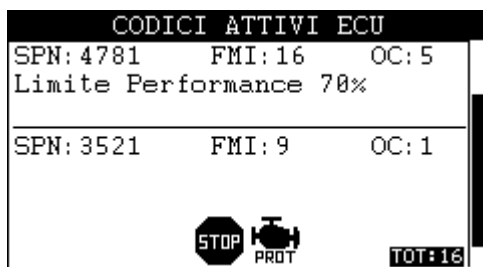

The icons in the lower centre indicate the status of the RED STOP/AMBER WARNING and MALFUNCTION/PROTECT signals sent by the DM1 command. Fault translations are:

SPN	FMI	FAULT
100	1	Low engine oil pressure
110	0	Engine overtemperature
190	0	Engine overspeed
111	1	Low coolant level
4781	15	Performance limit 50%
4781	16	Performance limit 70%
5838	31	Impeded EGR valve

FPT STAGE V ENGINES

CONNECTIONS

For connection to the engine, refer to the following table:





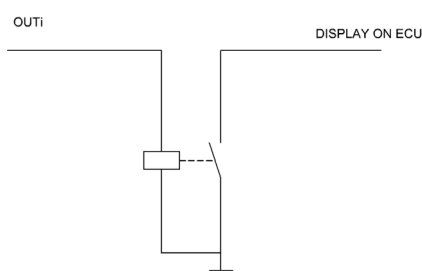









Colour	Terminal	ECU Terminal	Function
YELLOW	BLACK A6	+15 KEY SW IN	ECU activation
SCREENED CABLE	BLACK C2	CAN H	ECU communication
	BLACK C3	CAN L	
GREEN	BLACK B4	D+ charging lamp	Alternator pre-excitation and condition check
BLACK	BLACK B1	+50 CRANK IN	Engine starting
Any programmable output: OUTi		DISPLAY ON	Signals the activity to the ECU.

It is necessary to activate the "CONTROL UNIT ON" function on the output used for the DISPLAY ON of the ECU; the connection must be made as follows:

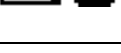

SIGNALLING LAMPS

The instrument LAMPS displays the information sent by the engine ECU via a symbol and an explanatory message. The table shows all the signals managed by the control unit and the likely corresponding fault.

Symbol	Signal	Fault
	High liquid coolant temperature warning	Warning overtemperature detected by the ECU
	High liquid coolant temperature	Overtemperature detected by the ECU
	Low engine oil pressure	Low oil pressure detected by the ECU
	Glow plugs preheating in progress	
	Water in fuel	
	Air Filter clogged	
	Fuel Pre-Filter clogged	
	Fuel Filter clogged	
	Automatic catalyst management required	
	Catalyst management on going	
	Catalyst management required Mid Level	
	Catalyst management Required High Level	
	EGR/DPF Inducement Final Step	
	Automatic catalyst management on going	
	Automatic catalyst management inhibited	
	Catalyst management inhibited	
	Catalyst management inhibited	
	Low idle increase level 2	
	EGR/DPF Inducement First Step	
	DEF System Tampering Level 1	
	Low Reagent Level < 10%	
	Poor reagent quality Level 1	
	EGR/DPF Inducement Second Step	
	DEF System Tampering Level 2	
	Low Reagent Level < 5%	
	Poor reagent quality Level 2	
	EGR/DPF Inducement Final Step	
	DEF System Tampering Level 3	
	Low Reagent Level = 0%	
	Poor reagent quality Level 3	
	Engine oil change required	

MANAGEMENT OF EMISSIONS REDUCTION DEVICES

The control unit supports the emissions reduction system for FPT Stage V4 engines equipped with MD1 engine control unit. Regeneration operations for the catalytic converter can be handled on the control unit panel and you have the option to see the related information.

REGENERATION

There are several regeneration modes:

- AUTOMATIC REGENERATION

This is set off automatically and periodically by the engine ECU and ends only when conditions are suitable (temperature at the exhaust, engine speed, etc.) for a sufficient period of time. There is the possibility to enable/disable automatic regeneration via the parameter in ENGINE ECU > FPT S5 PARAMETERS > AUTOMATIC REGENERATION.

You can follow the status of the automatic regeneration through the signals in the instrument LAMPS.

- MANUAL REGENERATION

Must be performed under required engine conditions (load, speed, etc.) and a consent has to be given to start it. There is the possibility to enable/disable manual regeneration via the parameter in ENGINE ECU > FPT S5 PARAMETERS > MANUAL REGENERATION.

When the engine ECU signals the request for manual regeneration, the instrument REGENERATION is activated, prompting the operator to give the consent to start the procedure, which must be carried out under safe conditions. It is possible to program the control unit in order to use an external selector/switch to signal that the safety conditions have been verified and then provide consent for regeneration; see the input function REGENERATION CONSENT. If you do not want to use any external consent, only a message reminding the operator to check the safety conditions before starting regeneration will be displayed

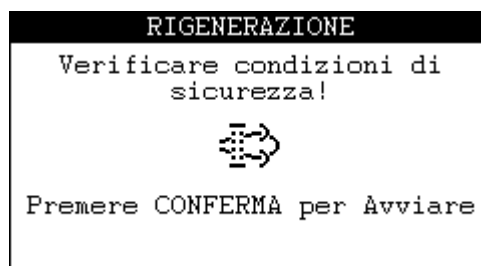
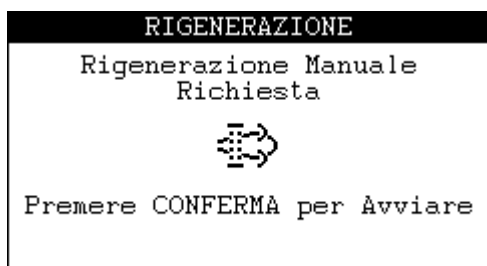

In both cases the operator will be requested to start the procedure by pressing and holding the CONFIRM_BUTTON for around 3 seconds.

With regeneration in progress, it can be interrupted, if using the external consent a request is made to remove it, otherwise once again by pressing and holding the CONFIRM_BUTTON for 3 seconds.

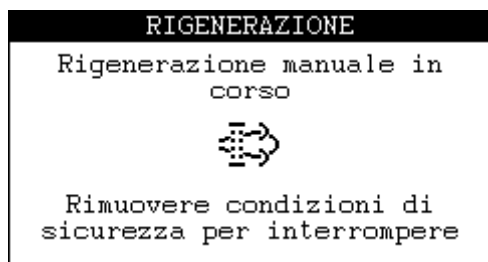

You can follow the status of the manual regeneration through the signals in the instrument LAMPS.

- SERVICE REGENERATION

When the particulate build-up level in the DPF rises to the point of exceeding a certain threshold, significant engine derating occurs. In this case, Service will need to intervene.

OIL COUNTER RESET

The engine ECU relies on counters to track the quality of the engine oil based on the time since the last change, the specific use, and the number of regenerations made.

Once a certain threshold is exceeded, the ECU gives a signal to change the oil, displayed in the instrument LAMPS.

After changing the engine oil, these counters have to be reset to inform the ECU of the change; the reset must be carried out with the engine off and the control unit in AUT or MAN.

From the HOUR METER instrument you will need to press the UP_BUTTON to access the OIL COUNTERS RESET instrument, with which it is possible to reset the oil counters by pressing and holding the CONFIRM_BUTTON for around 3 seconds.

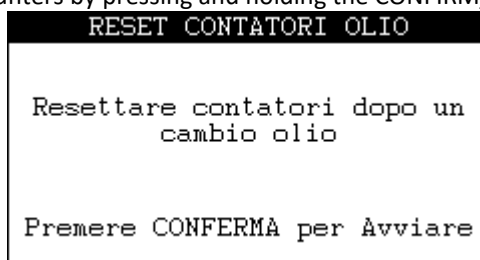

DOOSAN STAGE V ENGINES









CONNECTIONS

For connection to the engine, refer to the following table:

Colour		Terminal	Function
YELLOW		BLACK A6	ECU activation
SCREENED CABLE	WHITE	BLACK C2	ECU communication
	BROWN	BLACK C3	
GREEN		BLACK B4	Alternator pre-excitation and condition check
BLACK		BLACK B1	Engine starting

SIGNALLING LAMPS

The instrument LAMPS displays the information sent by the engine ECU via a steady or flashing symbol and an explanatory message. The table shows all the signals managed by the control unit.

Symbol	Flash	Signal
	Steady	Oil level too high
		Low oil level warning
		Low oil level
		Very low oil level
		Engine oil change required
	Steady	Glow plugs preheating in progress
	Steady	Water in fuel
	Steady	Catalyst management on going
	Slow	Catalyst management required
	Fast	Catalyst management required
	Steady	Automatic catalyst management on going
	Steady	Automatic catalyst management inhibited
	Steady	Low Reagent Level < 25%
	Slow	Low Reagent Level < 10%
	Fast	Low Reagent Level < 2.5%
	Steady	EGR/DEF Inducement First Step
	Slow	EGR/DEF Inducement Second Step
	Fast	EGR/DEF Inducement Final Step

MANAGEMENT OF EMISSIONS REDUCTION DEVICES

The control unit supports the emissions reduction system for Doosan Stage V engines.

Regeneration operations for the particulate filter can be handled on the control unit panel and you have the option to see the related information.

REGENERATION

There are several regeneration modes:

- **AUTOMATIC REGENERATION**

This is set off automatically and periodically by the engine ECU and ends only when conditions are suitable (temperature at the exhaust, engine speed, etc.) for a sufficient period of time.

You can follow the status of the automatic regeneration through the signals in the instrument LAMPS.

For reasons of safety, it is possible to enable/disable regeneration using the REGENERATION tool. The tool is always active in manual and automatic mode:

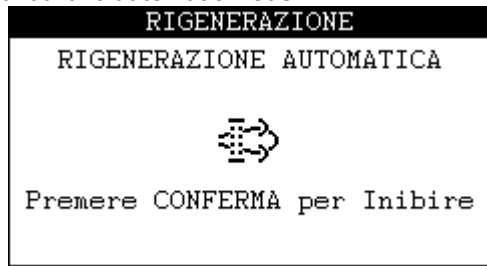

- MANUAL REGENERATION

Must be performed under required engine conditions (load, speed, temperature, soot level etc.) and a consent has to be given to start it.

If for some reason it cannot be performed, the engine ECU sends the Catalyst management inhibited signal visible in the LAMPS instrument; if the signal is not present, with the engine running and the engine protection active, the REGENERATION instrument is activated, with which it is possible to provide consent for the start-up of the procedure, which must be performed under safe conditions. It is possible to program the control unit in order to use an external selector/switch to signal that the safety conditions have been verified and then provide consent for regeneration; see the input function REGENERATION CONSENT. If you do not want to use any external consent, only a message reminding the operator to check the safety conditions before starting regeneration will be displayed

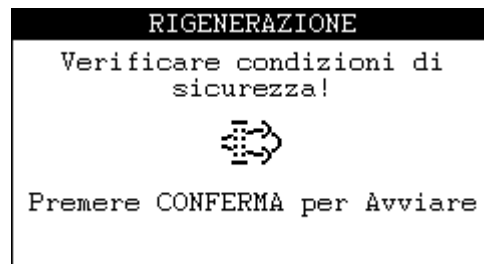
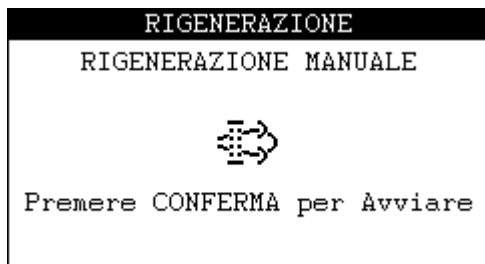

In both cases the operator will be requested to start the procedure by pressing and holding the CONFIRM_BUTTON for around 3 seconds.

With regeneration in progress, it can be interrupted, if using the external consent a request is made to remove it, otherwise once again by pressing and holding the CONFIRM_BUTTON for 3 seconds.

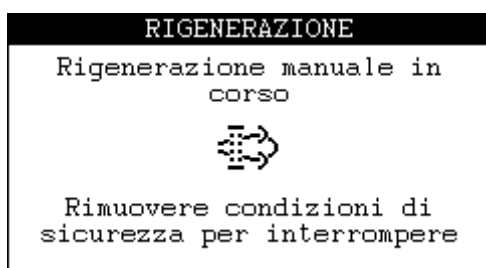

You can follow the status of the manual regeneration through the signals in the instrument LAMPS.

- SERVICE REGENERATION

When the particulate build-up level in the DPF rises to the point of exceeding a certain threshold, significant engine derating occurs. In this case, Service will need to intervene.

DEUTZ STAGE V ENGINES









CONNECTIONS

For connection to the engine, refer to the following table:

Colour	Terminal	ECU Terminal	Function
YELLOW	BLACK A6	+15 KEY SW IN	ECU activation
SCREENED CABLE	WHITE	BLACK C2	CAN H
	BROWN	BLACK C3	CAN L
GREEN	BLACK B4	D+ charging lamp	Alternator pre-excitation and condition check
BLACK	BLACK B1	+50 CRANK IN	Engine starting

SIGNALLING LAMPS

The instrument LAMPS displays the information sent by the engine ECU via a steady or flashing symbol and an explanatory message. The table shows all the signals managed by the control unit.

Symbol	Flash	Signal
	Steady	Glow plugs preheating in progress
	Steady	RADIATOR FAULT
	Steady	Low engine oil pressure
	Steady	Catalyst management on going
	Slow	Catalyst Management Required
	Fast	SERVICE regeneration in progress
	Steady	Exhaust system temperature too high
	Steady	Catalyst management inhibited
	Steady	Emission control system tampering
	Steady	Engine performance limitation
	Slow	Catalyst management Required SERVICE

MANAGEMENT OF EMISSIONS REDUCTION DEVICES

The control unit supports the emissions reduction system for Deutz Stage V Engines equipped with control units EMR4, EMR5 e EMR-L1.

Regeneration operations for the particulate filter can be handled on the control unit panel and you have the option to see the related information.

REGENERATION

There are several regeneration modes:

AUTOMATIC REGENERATION

This is set off automatically and periodically by the engine ECU and ends only when conditions are suitable (temperature at the exhaust, engine speed, etc.) for a sufficient period of time.

You can follow the status of the automatic regeneration through the signals in the instrument LAMPS.

MANUAL REGENERATION

Must be performed under required engine conditions (load, speed, temperature, soot level etc.) and a consent has to be given to start it.

If for some reason it cannot be performed, the engine ECU sends the Catalyst management inhibited signal visible in the LAMPS instrument; if the signal is not present, with the engine running and the engine protection active, the REGENERATION instrument is activated, with which it is possible to provide consent for the start-up of the procedure, which must be performed under safe conditions. It is possible to program the control unit in order to use an external selector/switch to signal that the safety conditions have been verified and then provide consent for regeneration; see the input function REGENERATION CONSENT. If you do not want to use any external consent, only a message reminding the operator to check the safety conditions before starting regeneration will be displayed

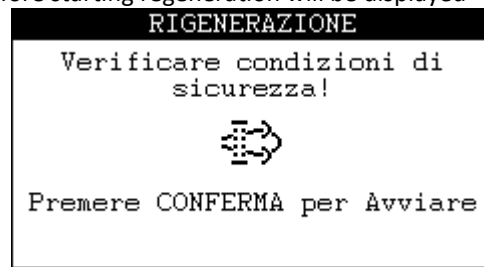
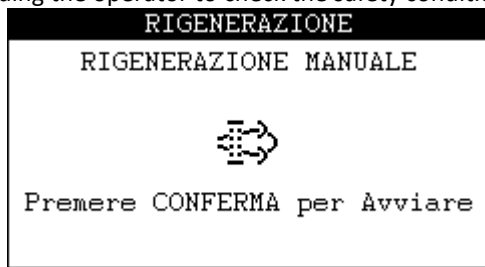

In both cases the operator will be requested to start the procedure by pressing and holding the Press CONFIRM... for around 3 seconds.

With regeneration in progress, it can be interrupted, if using the external consent a request is made to remove it, otherwise once again by pressing and holding the Press CONFIRM... for 3 seconds.



You can follow the status of the manual regeneration through the signals in the instrument LAMPS.

- **SERVICE REGENERATION**

When the particulate build-up level in the DPF rises to the point of exceeding a certain threshold, significant engine derating occurs. In this case, Service will need to intervene through the signals in the instrument LAMPS.

OPERATION

START_STOP_BUTTON

Used to:

- **Switch on the control unit.** If the control unit is switched off, press the button for at least one second; the control unit will switch on, performing an LED test and checking for any faults.
- **Start the pump.** If there are no faults which stop it, the engine driven pump will start at idling speed. If, on the other hand, there are faults which result in stoppage, the start-up will not occur.
- **Stop the pump.** If the engine driven pump is running, press the button for at least one second. The control unit will activate the linear actuator, reducing the RPM until the engine reaches minimum speed, and then will stop the engine.

ACCELERATE_BUTTON and DECELERATE_BUTTON

The ACCELERATE_BUTTON and DECELERATE_BUTTON are used to accelerate and decelerate the engine manually. When the control unit is on, the buttons are always active, even when the engine is not running.

UP_BUTTON, DOWN_BUTTON, LEFT_BUTTON and RIGHT_BUTTON

Used to browse display menus. They silence the alarm.

START/STOP

The pump can be started in any one of the following ways:

- By pressing the START_BUTTON.
- When the logic of the function-inputs FLOAT STOP / FLOAT START starts, see section START AND STOP FLOAT SWITCHES
- When function-input CALL is activated
- Remotely, with SMS command or with app

Any one of the following stops the pump:

- Pressing the STOP_BUTTON:
The engine is decelerated and then stopped.
- A stop-causing fault:
The engine is decelerated and/or cooled (if so required by the fault that caused the stop) and stopped.
- The TIMER, when the set operation time elapses:
The engine is decelerated, cooled (if enabled) and stopped.
- When the logic of the function-inputs FLOAT STOP / FLOAT START stops
- Upon deactivation of the function-input CALL
- When LOCK mode is set
- When, with PUMP PROTECTIONS ACTIVE, the function-input FLOW SWITCH is activated
- When the function-input LOCK is active
- Remotely, with SMS command or with app
- END OF WORK

DECELERATION

If a linear actuator is installed and a stop occurs, the control unit decelerates automatically and stops the engine when the rpm remains unchanged for 5 consecutive seconds. There are some fault-generated stops that do not contemplate a deceleration.

COOLING

During automatic stops or fault-generated stops (where contemplated) the engine is cooled while running for a set time after deceleration.

MANUAL IRRIGATION MODE

The operator has to start the engine and accelerate or decelerate it until the desired working pressure is reached. If the tubes of the irrigation system are long, we recommend disabling the pump protections temporarily with the specific button until water flows out of the nozzle; you can then re-enable the pump protections. Read the section PUMP PROTECTIONS.

Typically, when the irrigation system finishes its work, the pump is stopped due to a low water pressure fault if the discharge valve opens or due to high water pressure if the outlet valve closes.

AUTOMATIC IRRIGATION MODE

When the operator starts the engine-driven pump and sets it to MODE = AUT, the control unit runs a system check based on the CONTROL MODE parameter:

PRESSURE

The control unit operates to maintain the working pressure – bar – constant. The operator has to start the engine and use the front buttons to accelerate or decelerate it until the desired working pressure (setpoint) is reached; this also applies in MODE = MAN. 10 seconds after the buttons have been pressed, the message Operating point achieved will appear. Auto-detection also kicks in when switching from MANUAL to AUTOMATIC mode and the engine is running. From this moment, the control unit attempts to maintain the pressure constant. Based on the OPERATING POINT RESET setting, the setpoint is reset every time there is a stop if the parameter has been included; otherwise, the setpoint remains unchanged in the subsequent start-ups. Control unit CEM-196-10 provides the option to set the working pressure with SMS text commands or via app.

- PERMITTED FLUCTUATION. During normal operation, the control unit maintains the pressure constant by accelerating or decelerating the engine. This adjustment takes place only if the pressure variation exceeds the [FLUCTUATION] value. The factory setting for this value is 0.2 bar.
- END OF WORK. During the check, when all the irrigation systems have completed their cycles and the water flow stops, the pressure tends to increase. This prompts the control unit to bring the pressure back to the setpoint value by decreasing the engine's rpm. In this situation, however, the engine's rpm drops a great deal compared to the operating point. When, at the working pressure, the rpm drops below the set THRESHOLD (percentage) for the set DELAY, the control unit determines the END OF WORK end status and stops. A RESET restores the end of work.

- **ACCELERATION FAULT.** A water leak in the pipes causes the control unit to increase the engine's rpm as a way to restore the working pressure. If the rpm exceeds the set threshold percentage for the set time [ACCELERATION FAULT], the engine is stopped and the ACCELERATION FAULT fault is displayed.

SPEED

The control unit operates to maintain the diesel engine's RPM constant. The rpm can be defined in two different ways, depending on the parameter SETPOINT RPM > FUNCTION:

- **AUTOMATIC ACQUISITION:** The operator has to start the engine and use the front buttons to accelerate or decelerate it until the desired RPM is reached. 10 seconds after the buttons have been pressed, the message Operating point achieved will appear. From this moment, the control unit attempts to maintain the RPM constant. Based on the WORKING PRESSURE RESET setting, the setpoint is reset every time there is a stop if the parameter has been included; otherwise, the setpoint remains unchanged in the subsequent start-ups.
- **STATIC SETPOINT:** The setpoint is set statically in the parameter setting SETPOINT RPM > SETPOINT

To avoid unwanted fluctuations, there is a modifiable parameter [RPM TOLERANCE] that lets you define the threshold value to stop the control unit from adjusting the rpm in the event of variations.

COMBINED

If the function-input PRESSURE CONTROL is activated, the control unit operates the pressure control; otherwise, it operates the speed control.

ADJUSTMENT

If the pressure or speed falls outside the setpoint tolerance values (fluctuation and RPM tolerance) the control unit will do the following:

MECHANICAL ENGINES:

- Operates the actuator for a time equal to VAR ACTIVATION TIME
- Waits for a time equal to VAR PAUSE TIME

ELECTRONIC ENGINES:

- Send the TSC1 rpm setting command to the engine ECU with a value equal to the current value +/- RPM VARIATION STEP
- Waits for a time equal to RPM VARIATION TIME

The process ends when the control has been restored. If the operation does not take place within the MAXIMUM ADJUSTMENT TIME time, the process is interrupted and an ADJUSTMENT ERROR is generated.

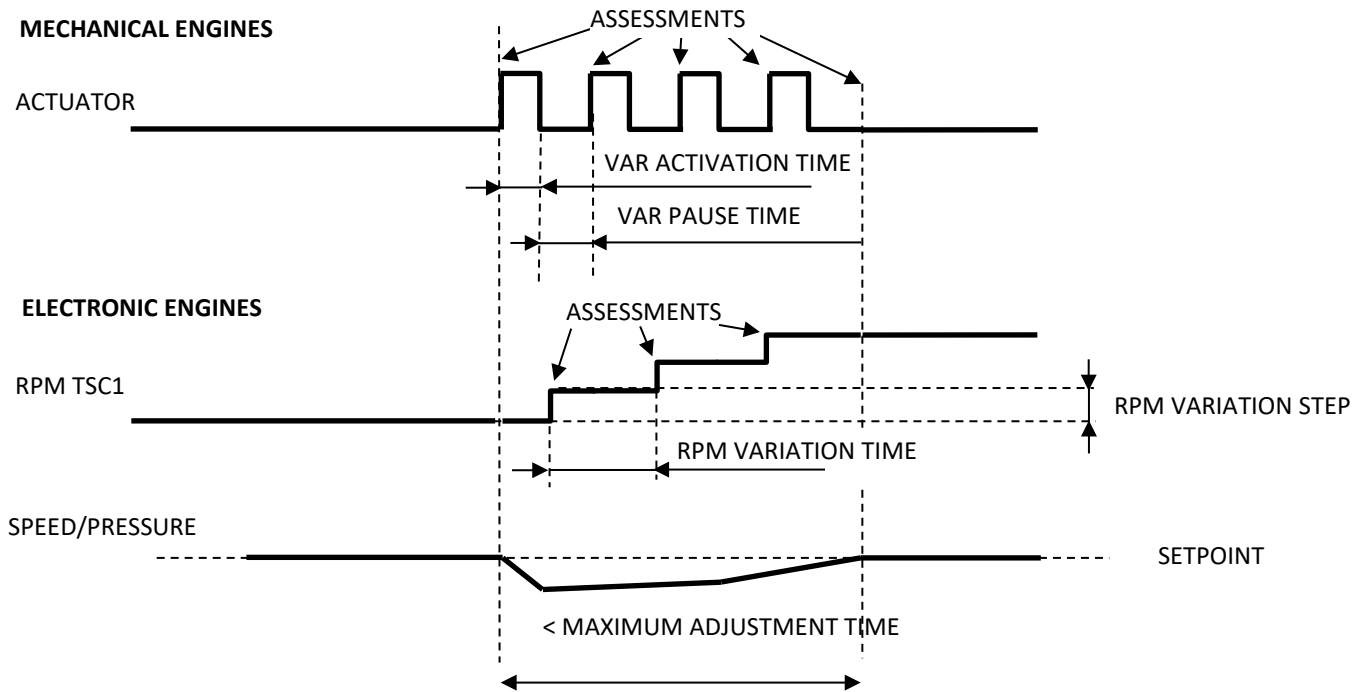

Auto-detected pressure and speed values are maintained in the control unit's battery-powered memory; this means they are kept stored even if a power disconnection occurs.

IRRIGATION OFF MODE

The engine-driven pump cannot be started in any way and if running, it is instantly stopped.

TABLE OF IRRIGATION MODES AND SETTINGS

The following is a table that recaps the main differences between the irrigation modes (manual, automatic) and the related settings.

SETTINGS		MODE	WARM-UP	PIPE FILLING	OPERATION
CONTROL	PUMP PROTECTION SENSOR				
PRESSURE	WATER PRESSURE TRANSM.	AUT	YES	YES	The pressure of the system is kept constant regardless of water flow.
		MAN	NO	NO	No control is operated.
	PUMP PRESSURE SWITCH	AUT	-	-	MODE not allowed.
		MAN	NO	NO	No control is operated.
SPEED	WATER PRESSURE TRANSM.	AUT	YES	NO	Engine speed is kept constant regardless of water flow.
		MAN	NO	NO	No control is operated.
	PUMP PRESSURE SWITCH	AUT	YES	NO	Engine speed is kept constant regardless of water flow.
		MAN	NO	NO	No control is operated.
COMBINED	WATER PRESSURE TRANSM.	AUT	YES	YES/NO	The system pressure or speed (see function-input PRESSURE CONTROL) is kept constant regardless of water flow. Pipe filling is active if in that moment there is a pressure control, otherwise it is not active.
		MAN	NO	NO	No control is operated.
	PUMP PRESSURE SWITCH	AUT	-	-	MODE not allowed.
		MAN	NO	NO	No control is operated.

When the function is enabled, the TIME and ACTIVATION settings of the input used are ignored.
 Once the function is enabled, you will have access to the “DISPENSED WATER” tool, and the same value will be made available on the APP.

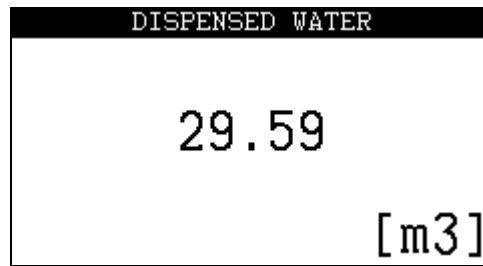

PRESSURE

In order to meter the amount of water dispensed, an estimate is made based on the pressure at the nozzle (calibrated orifice); this is equal to the pressure at the transmitter minus a constant pressure drop:

IRRIGATION > DISPENSED WATER > PRESSURE DROP.

The flow rate is considered non-zero only with the engine running.

It is necessary to set the nozzle size at the jet:

IRRIGATION > DISPENSED WATER > REFERENCE > SPRINKLER NOZZLE

If more accurate nozzle data are available, it is possible to set the “CUSTOM” nozzle and store the reference flow rate directly:

IRRIGATION > DISPENSED WATER > REFERENCE > PRESSURE, pressure value [BAR]

IRRIGATION > DISPENSED WATER > REFERENCE > WATER FLOW flow rate value [l/min]

In pressure mode, the instantaneous flow rate tool is also available (in [m3/h]):

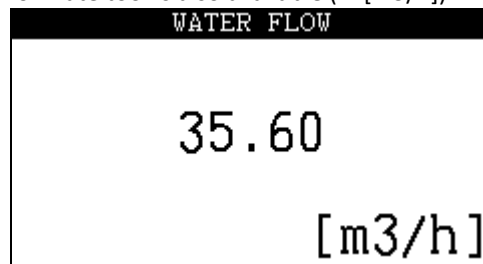

START AND STOP FLOAT SWITCHES

Use of the function-inputs FLOAT STOP / FLOAT START results in an adequate tank filling or emptying operation: These sensors have an open contact in the absence of water and a closed contact in the presence of water.

FILLING

Set the function-inputs FLOAT STOP / FLOAT START as OPEN.

Place the START float switch at the bottom and the STOP float switch at the top.

- When the function-input FLOAT START is activated (if the function-input FLOAT STOP is active), the engine is started: START stage.
- The engine is kept running even if the function-input FLOAT START deactivates; FILLING stage.
- The engine is stopped when the function-input FLOAT STOP deactivates: STOP stage.
- If, after the stop, the function-input FLOAT STOP activates, the engine is not started: EMPTYING stage.
- If during the FILLING stage the engine is stopped, the process is interrupted; the engine will be restarted when the function-input FLOAT START deactivates: EMPTYING stage.

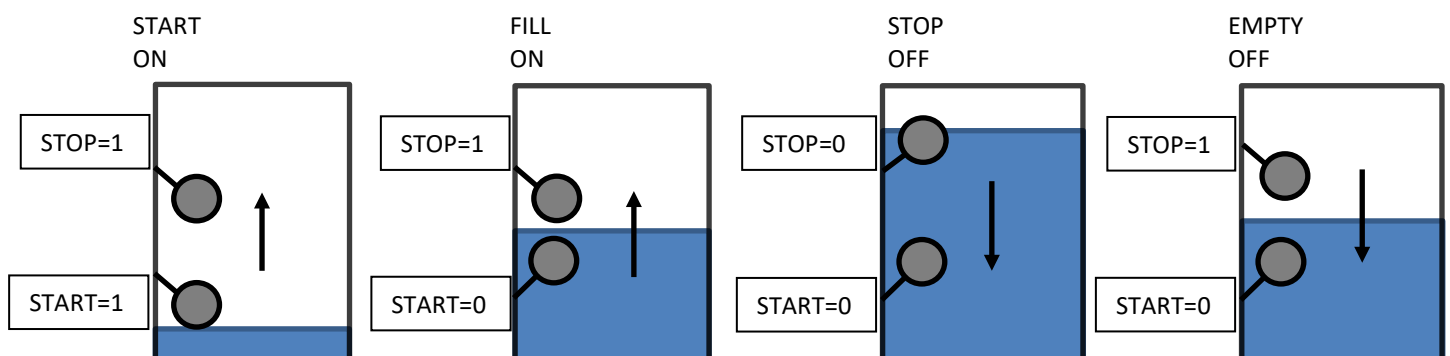

EMPTYING

Set the function-inputs FLOAT STOP / FLOAT START as OPEN.

Reverse the position of the float switches with respect to filling: START at the top and STOP at the bottom.

The following operation will ensue:

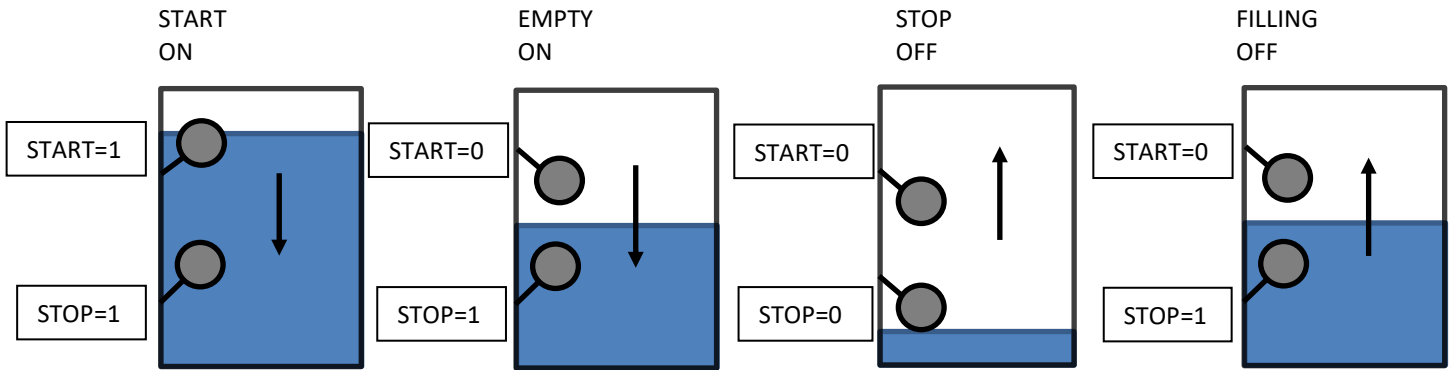

ENGINE PROTECTIONS

ACTIVATION

Engine protections are enabled after $\text{ENGINE} > \text{ENGINE PROTECTION DELAY}$ seconds (factory setting = 20) 20 seconds after the end of the start-up impulse and disabled when the motor is stopped. When the protections are active, the `ENGINE_PROTECTIONS_ACTIVE_LED` lights up.

PROTECTIONS

Faults of the engine protection probes are indicated by the `RED_ALARM_LED` (lights up if fault causes engine stop) and `YELLOW_ALARM_LED` (lights up if fault does not cause a stop).

See list of engine faults, activation column. `ENGINE PROTECTIONS ACTIVE`.

PUMP PROTECTIONS

ENABLING

If $\text{IRRIGATION} > \text{PUMP PROTECTION SENSOR} = \text{WATER PRESSURE TRANSM.}$ is set, the pump protections enable with the engine running after a time equal to $\text{IRRIGATION} > \text{PROTECTION ACTIVATION TIME} > \text{MINIMUM}$ (factory set at 2) consecutive minutes, during which the following two conditions are verified:

- The water pressure remains stable; there are no oscillations greater than 2 BAR
- The water pressure is greater than the value of $\text{IRRIGATION} > \text{MINIMUM PRESSURE}$.

If $\text{IRRIGATION} > \text{PUMP PROTECTION SENSOR} = \text{PUMP PRESSURE SWITCH}$ is set, the pump protections enable with the engine running after a time equal to $\text{IRRIGATION} > \text{PROTECTION ACTIVATION TIME} > \text{MINIMUM}$ (factory set at 2) consecutive minutes, during which the function-input `PUMP PRESSURE SWITCH` did not activate.

In any case, the pump protections enable with the engine running after a time $\text{IRRIGATION} > \text{PROTECTION ACTIVATION TIME} > \text{MAXIMUM}$ minutes (factory set at 10).

When the protections are active, the `PUMP_PROTECTIONS_ACTIVE_LED` lights up.

Pump protections deactivate at the start of the engine stopping procedure.

If the pump protections are active and the `DECELERATE_BUTTON` or `ACCELERATE_BUTTON` is pressed, the protections are deactivated for a time equal to $\text{IRRIGATION} > \text{PROTECTION ACTIVATION TIME} > \text{RESTART}$; factory setting is 10".

PUMP PROTECTION DISABLE BUTTON

To disable the pump protections, press the `PUMP_PROTECTIONS_DISABLE` button for at least 3 consecutive seconds with the engine running; the `PUMP_PROTECTIONS_DISABLED_LED` will flash to confirm they have been disabled. All controls except fault "Water pump maximum pressure" and "Water pump pressure transmitter fault", will be disabled.

Pressing the button again or stopping the pump will cancel the disable command.

WATER PRESSURE TRANSM.

When the pump is controlled by the `WATER PRESSURE TRANSM.`, all the protections use the pressure value readings as the baseline.

Water pump maximum pressure

If the water pressure reading from the transmitter exceeds the threshold of IRRIGATION > MAXIMUM PRESSURE, the control unit activates the fault “Water pump maximum pressure “ and stops the pump at once. This control is always active.

MINIMUM PRESSURE

If the working pressure is less than or equal to IRRIGATION > MINIMUM PRESSURE (factory set at 0.2), activation of the protections triggers the fault Water pump underpressure and the engine is stopped.

Water pump pressure transmitter fault

If the pressure transmitter (TPA) is disconnected or breaks, the fault “Water pump pressure transmitter fault” is triggered.

If the fault appears when the engine is started, it will stop the engine after 2 seconds.

If the fault appears before starting the engine, it will stop the engine 1 minute after the engine is started.

OVERPRESSURE AND UNDERPRESSURE

With pump protections active, if the pump pressure exceeds the OVERPRESSURE value, the fault “Water pump overpressure” is triggered; likewise, if the pressure drops below the UNDERPRESSURE value, the fault Water pump underpressure is activated. Both faults stop the engine. UNDERPRESSURE and OVERPRESSURE values are established in two different ways depending on how the parameter IRRIGATION > PROTECTION TYPE is set.

AUTOMATIC ACQUISITION (factory setting)

When pump protections are activated, the unit takes the water pressure as the WORKING PRESSURE.

If the working pressure is greater than or equal to 4 bar:

- $OVERPRESSURE = WORKING PRESSURE + [HIGHER OVERPRESSURE DIFFERENTIAL]$ (factory set at 2 bar)
- $UNDERPRESSURE = WORKING PRESSURE - [HIGHER UNDERPRESSURE DIFFERENTIAL]$ (factory set at 2 bar)

If the working pressure is less than 4 bar:

- $OVERPRESSURE = WORKING PRESSURE + [LOWER OVERPRESSURE DIFFERENTIAL]$ (factory set at 1 bar)
- $UNDERPRESSURE = WORKING PRESSURE - [LOWER UNDERPRESSURE DIFFERENTIAL]$ (factory set at 1 bar)

Where:

[HIGHER UNDERPRESSURE DIFFERENTIAL] is the parameter
IRRIGATION > PUMP WATER UNDERPRESSURE > UPPER DIFFERENTIAL

[LOWER UNDERPRESSURE DIFFERENTIAL] is the parameter
IRRIGATION > PUMP WATER UNDERPRESSURE > LOWER DIFFERENTIAL

[LOWER OVERPRESSURE DIFFERENTIAL] is the parameter
IRRIGATION > PUMP WATER OVERPRESSURE > LOWER DIFFERENTIAL

[HIGHER OVERPRESSURE DIFFERENTIAL] is the parameter
IRRIGATION > PUMP WATER OVERPRESSURE > UPPER DIFFERENTIAL

If the WORKING PRESSURE is lower than the UNDERPRESSURE DIFFERENTIAL value (whether LOWER or HIGHER), the UNDERPRESSURE value is set to the value of IRRIGATION > MINIMUM PRESSURE.

Water underpressure and overpressure thresholds can be changed manually at any time; see PUMP INSTRUMENT.

MANUAL ACQUISITION

This type of protection can be included when the pump is started automatically upon closing of the remote start contact (float switch, pressure switch, generic contact, etc.) and the linear actuator is excluded. The engine rpm must be pre-set by mechanically operating the engine accelerator. The function is valid only in MAN Irrigation Mode. The operator must set the WORKING PRESSURE from the PUMP DASHBOARD. The value is stored in a non-volatile memory and is therefore maintained even if the control unit battery is disconnected. If the pump protections are active, they are deactivated and then activated again after 8 seconds, setting the new limit values. The programming is made when you exit the edit mode.

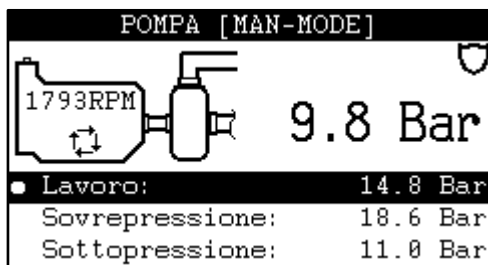

- $OVERPRESSURE = WORKING PRESSURE + [OVERPRESSURE PERCENTAGE]$ (factory set at 26%)
- $UNDERPRESSURE = WORKING PRESSURE - [UNDERPRESSURE PERCENTAGE]$ (factory set at 26%)

Where

[OVERPRESSURE PERCENTAGE] is the parameter
IRRIGATION > PUMP WATER OVERPRESSURE > DIFFERENTIAL

[UNDERPRESSURE PERCENTAGE] is the parameter
IRRIGATION > PUMP WATER UNDERPRESSURE > DIFFERENTIAL

The parameter IRRIGATION > PROTECTION TYPE must be programmed as MANUAL ACQUISITION.

PUMP PRESSURE SWITCH

When the pump is controlled by PUMP PRESSURE SWITCH, all the protections use the function-input PUMP PRESSURE SWITCH as the baseline; it is therefore necessary to connect a pressure switch to an adequately programmed input.

Upon activation of the function-input PUMP PRESSURE SWITCH and once the time IRRIGATION > PUMP PRESSURE SWITCH DELAY has elapsed, if the pump protections are active, the fault Water pump underpressure will occur.

FILTER WASHING

When the function-input FILTER WASH is active, the UNDERPRESSURE value changes and is equal to IRRIGATION > FILTER WASH > PRESSURE. When the function-input deactivates, the UNDERPRESSURE value returns to the previous value.

If the function FILTER WASH (IRRIGATION > FILTER WASH > FUNCTION) is disabled, the function-input is not active.

CAVITATION

The control unit checks whether there is potential cavitation occurring in the pump; the method used is the intake vacuum measurement. The supported sensors are of 4-20mA type, the management must be enabled by selecting the SENSOR sensor in the menu IN-OUT> IN 4-20 mA > SENSOR

The management incorporates four independent faults:

- CAVITATION PRE-ALARM: The vacuum value remains below the set threshold and the intervention delay has passed; reset when the value normalises for more than 5 seconds.
- CAVITATION ALARM: The vacuum value remains below the set threshold and the intervention delay has passed; is not reset. Stops the machine.
- VACUUM TX INTERRUPTED: The signal read is anomalous for over 5 seconds; resets when the signal is normal for more than 5 seconds.
- EXCESSIVE CAVITATION TIME: the pump has worked with CAVITATION PRE-ALARM active for longer than a threshold which can also be set non continuously. The total time can be reset in the menu IN-OUT> IN 4-20 mA > EXCESSIVE CAVITATION TIME > RESET HOURS

It is necessary to program the fault levels and specify the sensor used; see 4-20mA sensor programming.

If the VACUUM TX value is enabled, this is indicated in the PUMP instrument

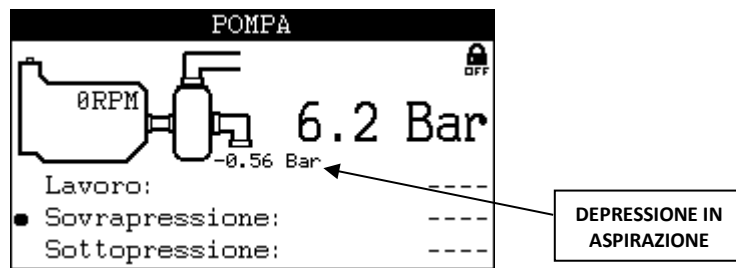

RESET

The device is reset via the RESET command in the main DASHBOARD. The following operations are carried out:

- Active faults restored
- Engine protection timer restored.
- Pump protection timer restored.
- Stop TIMER restored if it stopped the control unit.
- Stop from function-input FLOW SWITCH restored.

EMERGENCY STOP

This is available in all operating modes. It is possible to install (hook mount) one or more buttons. Stopping is immediate, without engine deceleration; it activates the general alarm and **EMERGENCY STOP** is displayed.



Do not use the emergency button in combination with a stopping system that is not energized while running.

MODEM COMMANDS (CEM-196-10)

The control unit incorporates a telephone modem that is able to manage SMS text messages or communicate via the Elcos Smart Control app.

The following are possible:

- Start or stop the pump.
- Disable or enable pump protection.
- Set the minutes of operation.
- Verify the pump status.
- Be notified if the pump is in alarm status.
- Reset faults.

When using the system with SMS text messaging, at least one telephone number must be set in the control unit's phone book; this will be used to send fault notifications. If the IOT system is used instead, the mobile network operator's APN must be set in the control unit.

PROCEDURE TO DISABLE THE PIN

After purchasing a SIM Card from a mobile operator, regardless of the contract the customer has chosen, the PIN must be disabled. To do so, insert the SIM card into a normal mobile phone for personal use; turn on the phone and enter the PIN provided by the operator. Look through the mobile phone's menu to find the procedure to deactivate the PIN. Follow the deactivation procedure, so that when the SIM card is turned on again in the future, the PIN will not be requested. Turn off the cellphone and extract the SIM Card. Make sure the control unit is off and then insert the SIM card in the slot.

COMMISSIONING

To make sure the area surrounding the control unit is covered by signal, check the icon on the display. Place the antenna vertically using its magnetic support and at the point of maximum signal strength.

SMS

The SMS notification and SMS command mechanism is active if MODEM > SMS > FUNCTION = INCLUDED.

FAULT NOTIFICATION

When a fault occurs, if operation with SMS has been enabled, the control unit will sequentially send the text message (only once) to all the telephone numbers stored in the phone book.

START AND STOP NOTIFICATION CALENDAR

If MODEM > SMS > TEXT MSG START AND STOP = INCLUDED, as soon as the engine starts up or stops, the control unit will sequentially send a notification message (only once) to all the telephone numbers stored in the phone book.

END OF WORK NOTIFICATION

When MODEM > SMS > TEXT MSG AT END OF WORK = INCLUDED, the system will sequentially send a text message (only once) notifying the stop effected by the flow switch or stop timer to all the numbers stored in the phone book.

SMS COMMANDS

The following is the list of commands that can be sent to the control unit:

Numerical code	Text code	Description
001	STATUS1	PUMP status request: MOTOR PUMP is RUNNING. Hour meter =00:24 NO FAULTS PRESSURE =10.0 Bar PUMP PROTECTIONS INCLUDED UNDERPRESSURE =8.0 Bar OVERPRESSURE =12.0 Bar TIMER=00:01.31
002	STATUS2	ENGINE values status request: MOTOR PUMP is RUNNING. FUEL =100% ENGINE PRESSURE =8.9 Bar ENGINE TEMPERATURE =91°C RPM=0 BATTERY =12.9V
005	STOP	Stops the pump.
008	START	Starts the pump
010	PROT OFF	Disables the pump protections
011	PROT ON	Enables the pump protections
007	RESET	Resets the device
040	FUEL ON	Enables the FUEL FAULT
041	FUEL OFF	Disables the FUEL FAULT
050	AUT	Sets automatic irrigation
051	MAN	Sets manual irrigation
500#[minutes]	TIMER#[minutes]	Sets the minutes of operation on the timer, maximum 1440min (1day). Do not add spaces before or after the minutes.
1#[number]	T1#[number]	The telephone number of field [number] will be stored in the assigned phone book position, overwriting the current number (add the country code before the number). Do not add spaces before or after the number. To cancel a number, send the field [number] made up of only spaces.
2#[number]	T2#[number]	
3#[number]	T3#[number]	
4#[number]	T4#[number]	
5#[number]	T5#[number]	
101	TT1	The telephone number that sent the message will be stored in the assigned phone book position, overwriting the current number.
102	TT2	
103	TT3	
104	TT4	
105	TT5	
10#[apn of mobile operator]	APN#[apn of mobile operator]	Saves the mobile network operator's APN in the control unit. Do not add spaces before or after the APN.
200	ECHO NUM	Answers with the list of telephone numbers stored in the phone book and the APN stored in the control unit. Contacts: T1#+393245566741 T2#---- T3#+393245566741 T4#---- T5#+393487763267
300	ECHO APN	Answers with the list of the APN.
600#[BAR]	PRESS#[BAR]	Sets the working pressure: BAR. When the set pressure is reached, the corresponding RPM is detected and the new operating point defined. The pump protections are deactivated and then restored with the usual logic. The command is valid only in automatic mode.
601#[RPM]	RPM#[RPM]	Sets the working speed. When the set speed is reached, the corresponding pressure is detected and the new operating point defined. The pump protections are deactivated and then restored with the usual logic. The command is valid only in automatic mode.

When MODEM > SMS > TEXT MESSAGE FROM ALL = INCLUDED, the commands sent to the control unit will be accepted by all cellphones; otherwise, only by the phones stored in the control unit.

FUEL FAULT

Fault "FUEL FAULT" depends on any change in the fuel level in the motor pump tank when the engine is stopped. The control enables after receiving SMS command "040" or "FUEL ON" and disables by sending SMS "041" or "FUEL OFF". The control disables when battery power is disconnected.

The fault control, if enabled, activates 5 minutes after the engine is turned off and in that instant, the fuel level reference value is captured. A negative variation generates the fault: when the level is between 100% and 80%, the variation has to be 10%; when the level is between 79% and 1%, the variation has to be 5%. The fault is delayed by 5 seconds and is stored. The reference value and related variation are updated when the fault is restored, the control is activated or the tank is topped up.

An additional SMS "OFF state" is sent when the operator sets the control unit in LOCK MODE.

APP

Management via the app is active if MODEM > IOT > FUNCTION = INCLUDED

From the main app screen you can START/STOP and view the main values:

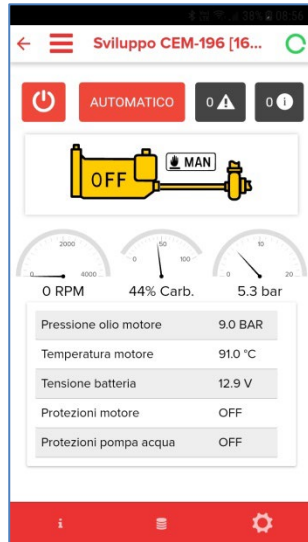

The following pages are also available:

- **FAULTS:** Displays current faults and lets you reset the device
- **MESSAGES:** Displays current messages and lets you reset the device
- **FUEL** (Access level: “manufacturer”)
 - FUEL LEVEL display
 - FUEL FINISHED setting
 - FUEL RESERVE setting
 - FUEL FAULT enablement
- **CLOCK SETTINGS:**
 - Total working hours display
 - Partial working hours display
 - Calendar clock setting
 - Stop timer setting
- **WATER PUMP:**
 - Pressure display
 - Regulation type display
 - Operating point display
 - Dispensed water display
 - RPM/pressure setpoint display
 - Pressure fault differentials display
 - Pump protections block/activation
- **SETTINGS:** (Access level: “manufacturer”) Various settings.
- **ECU DATA:** Display of data collected by the engine ECU.
 - Engine type
 - Temperature
 - Pressure
 - Levels
 - Fault codes

For additional information, refer to the “Elcos Smart Control” app documentation.

EVENT LOG

Up to 5375 events are stored. Data displaying in HISTORY > HISTORY is as follows:

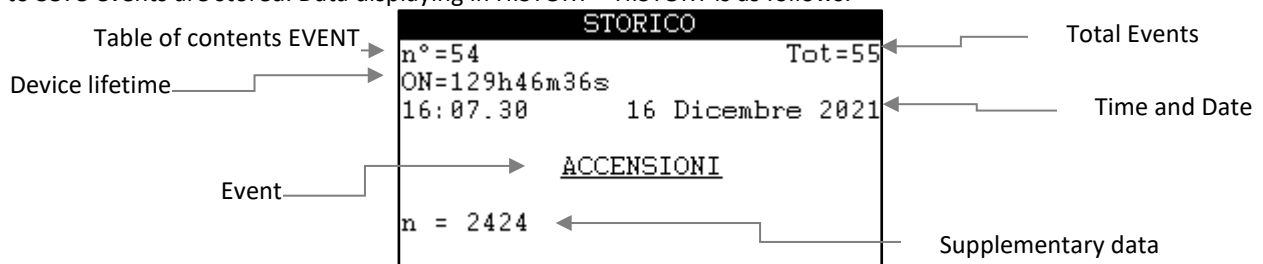

The event with the greatest number indicates the last event that occurred, 1 is the first. If no events are stored, the display shows HISTORY EMPTY.

The events are:

EVENT	DATUM 1	DATUM 2	SAVING
FAULT	ACTIVATED = Onset	NUMBER OF ACTIVE FAULTS	At fault onset/resolution.
	DEACTIVATED = Resolved		
MANUAL START REQUEST START REQUEST BY CALL FLOAT START REQUEST REMOTE START REQUEST	ACTIVATED	---	On presentation of request
	DEACTIVATED		
TIMER STOP REQUEST FLOW SWITCH STOP REQUES LOCK MODE STOP REQ. LOCK STOP REQUEST REMOTE STOP REQUEST END OF WORK STOP REQ.	ACTIVATED	---	On presentation of request
	DEACTIVATED		
SWITCH-ONS	Total number of start-ups	---	Upon start-up of device
ENGINE STARTED	Total hours[ECU]: (hh:mm)	---	As soon as an engine running is detected, stores the total engine running time.
ENGINE STOPPED	Partial hours: (hh:mm)	---	As soon as an engine stop is detected, stores the partial start time.
BATTERY VOLTAGE	V	---	Every day On start-up With engine running each hour
FUEL LEVEL	%	---	Every day On start-up With engine running each hour
ENGINE PROTECTIONS	ACTIVATED	---	On activation/deactivation of engine protections
	DEACTIVATED		
PUMP PROTECTIONS	ACTIVATED	EXCLUDED	On activation/deactivation of pump protections
	DEACTIVATED	INCLUDED	On disable/enable of pump protections
PRESSURE LIMITS	Min: BAR	Max: BAR	On activation of pump protections
WATER PRESSURE	BAR	---	With engine running every 15 minutes
MOTOR RPM	RPM	---	With engine running every 15 minutes
ENGINE TEMPERATURE	°C	---	With engine running every 15 minutes
OIL PRESSURE	BAR	---	With engine running every 15 minutes
WORKING PRESSURE	BAR	---	On activation of pump protections
LOW CONSUMPTION	ACTIVATED = Input	---	When in and out of POWER SAVING mode.
	DEACTIVATED = Output		
DELETE HISTORY	---	---	A delete has occurred in the event log.
PRIMING IN PROGRESS	ACTIVATED = IN PROGRESS	---	On start and end of the priming process.
	DEACTIVATED = COMPLETE		
PIPE FILLING	ACTIVATED = IN PROGRESS	---	On start and end of the pipe filling process.
	DEACTIVATED = COMPLETE		
RPM ADJUSTMENT	RPM	---	On activation of the automatic RPM adjustment process
"BAR ADJUSTMENT	BAR	RPM	On activation of the automatic pressure adjustment process
ADJUSTMENT DEACTIVATED	---	---	On deactivation of an automatic adjustment process.
FAULT RESET	---	---	On reset of the control unit.
MANUAL IRRIGATION MODE	---	---	Input in MANUAL mode.
AUTOMATIC IRRIGATION MODE	---	---	Input in AUTOMATIC mode.
IRRIGATION OFF MODE	---	---	Input in OFF mode.
PRIMING IN PROGRESS	---	---	Mode error.
VACUUM TX	BAR	---	With engine running each hour (when enabled)
ACTIVE CODES	Spn: n Fmi: n	ACTIVATED	On the onset/disappearance of an error sent by the ECU via CAN BUS
		DEACTIVATED	
REGENERATION	START	---	At the start and end of the regeneration procedure, for STAGE V engines only
	STOP		
DISPENSED WATER	m3	---	Every day On start-up With engine running each hour Only if the input function LITERS COUNTER is enabled

Example of Fault Event:

	STORICO	STORICO	
Fault onset, 1 faults active	n°=940 Tot=1004 ON=326h05m07s 11:04.58 12 Giugno 2023 <u>SOVRATEMPERATURA MOTORE</u> ATTIVO ANOMALIE INTERVENUTE: 1	n°=944 Tot=1004 ON=326h05m20s 11:05.10 12 Giugno 2023 <u>SOVRATEMPERATURA MOTORE</u> DISATTIVO ANOMALIE INTERVENUTE: 0	Fault resolved, 0 faults active

UP_BUTTON and DOWN_BUTTON modify the event index. To exit CONFIRM_BUTTON

POWER SAVING

With the engine stopped, the control unit goes into power saving mode after a certain period of inactivity. The parameters can be customised; see DEVICE > STAND-BY.

Under power saving mode, the modem is off; this means you will not be able to manage the control unit remotely. The function-input STANDBY BLOCK inhibits the POWER SAVING input when it is activated.

WAKE UP

To wake the device from power saving, hold the START_STOP_BUTTON down for some time.

You can also exit power saving via two inputs:

- IN BLACK/GREEN
- IN ORANGE/BROWN

The device can be programmed to wake up from power saving when the input is closed to ground or open. Wake-up is independent of the function-input or fault associated with the input.

INSTALLATION

STOPPING SYSTEMS

Stopping can be achieved in two ways:

- With the solenoid valve or electromagnet energized when the engine is running and de-energized when the engine is stopped (default setting, mandatory for electronic engine).
- With the electromagnet de-energized when engine is running and energized when it is stopped, remaining in this condition for the entire ENGINE > STOP > STOP TIME after engine not running has been detected.

If after ENGINE > STOP > FAILURE TO STOP – factory setting 120 seconds from receipt of the stop command – the control still detects the engine running signal, the “Failure of engine to stop” trips.

GLOW PLUGS

Activation of the GLOW PLUGS output is adjustable — from a minimum of 0 seconds (command off) to a maximum of 60 seconds. Once activation of the PREHEATING has been completed, the engine start-up procedure begins. POST-HEATING can also be managed, i.e. maintaining output live for a set amount of time, even after the engine has been started: see ENGINE > GLOW PLUGS

GENERAL ALARM

The GENERAL ALARM signal can be obtained by installing a signalling device at the specific output. It can be programmed (menu IN-OUT > GENERAL ALARM > DURATION) so that it is always on or remains on for a specific amount of time. It trips whenever the control unit detects a fault. Pressing one of the arrows silences the alarm.

IMMINENT START

Every automatic start-up is preceded by the intermittent activation of the general alarm output for 8 seconds; then, 3 seconds later, the start-up cycle begins. If a buzzer is connected to this output, the operator is notified that start-up is imminent. This function can be bypassed.

(IN-OUT > GENERAL ALARM > DURATION > IMMINENT START)

ENGINE RUNNING DETECTION

Engine running is detected by the voltage and by the frequency of the battery charger alternator (permanent or pre-excitation magnets). Once detected, the starter motor switches off.

TACHOMETER CALIBRATION

The control unit requires tachometer calibration. See the procedure in "SETTINGS>ENGINE>CHARGER ALTERNATOR>W ALTERNATOR>CALIBRATION".

CLUTCH

The clutch is engaged when the engine speed threshold INSERTION is reached (after the DELAY). To avoid unwanted disengagements after phases of engine acceleration, the clutch remains engaged until the control unit stops the pump. It disengages when the engine speed falls below the threshold RELEASE (after the DELAY) and the control unit is in stopping phase. This function is excluded by factory default. Be sure to direct the function CLUTCH to a programmable output.

ENGINE WARM-UP

Once engine start-up is completed, if the engine warm-up function is included, the engine will remain at idle speed for the time it takes to warm up. After this time has elapsed, the engine will reach working pressure. Protections are active during the warm-up. This function is excluded by factory default.

PUMP PRIMING

Pump priming is an automatic function that allows filling the main pump with water to prevent dry running of the impeller. This function is excluded by factory default. There are a number of pump priming modes. In priming modes where the diesel engine is running, only the engine protections are active, not the pump's.

When the control unit has to start the engine-driven pump, it checks for the presence of water in the main pump. This check is done in two ways:

- Through the water detection probe installed at the pump discharge.
- Through detection by the TPA-200 pressure transmitter of minimum pressure at the pump discharge.

If neither of these two conditions is met, the control unit starts the priming procedure under one of the following modalities:

- **PUMP PRIMING BEFORE START-UP**

The control unit activates the function-output PUMP PRIMING to which a pump (priming) that draws water from the water basin must be connected. The water must flow down inside the main pump. When the water level rises and the sensor detects the presence of water, or the pressure read by the TPA-200 exceeds the threshold PRIMING PRESSURE, the control unit waits for the PRIMING STABILISATION, turns off the pump, waits for the PRIMING END TIME, and then starts the diesel engine. If the presence of water is not detected for the PRIMING FAILURE TIME, the fault "Pump priming failure" will be generated and the system will be locked out. The function-output PRIMING IN PROGRESS will be active for the duration of the process.

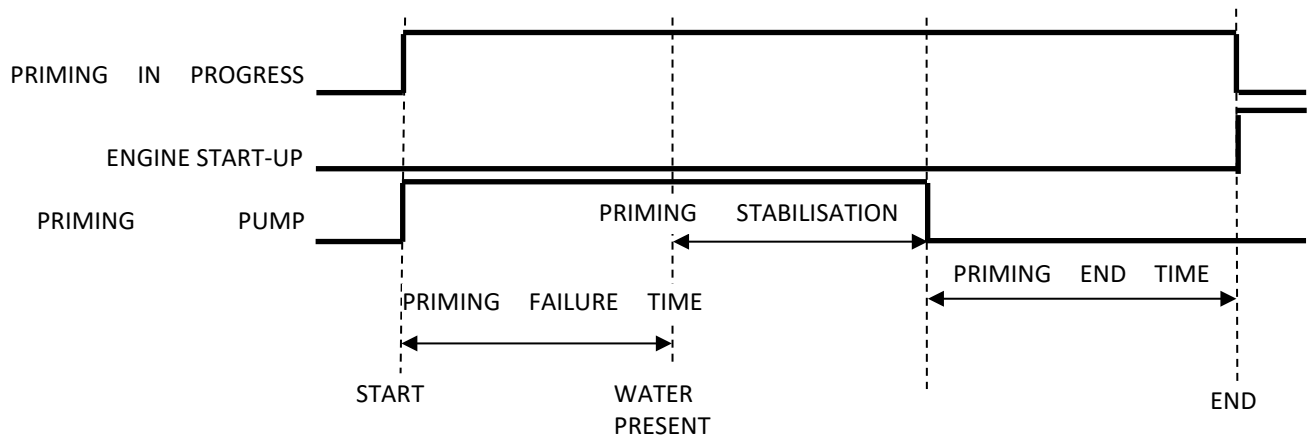

- **PUMP PRIMING AFTER START-UP**

The control unit starts the diesel engine and, with the engine running, activates the function-output PUMP PRIMING to which a pump (priming) that draws water from the water basin must be connected. The water must flow down inside the main pump. When the water level rises and the sensor detects the presence of water, or the pressure read by the TPA-200 exceeds the threshold PRIMING PRESSURE, the control unit waits for the PRIMING STABILISATION and turns off the pump. If the presence of water is not detected for the PRIMING FAILURE TIME, the fault “**Pump priming failure**” will be generated and the system stopped. The function-output PRIMING IN PROGRESS will be active for the duration of the process.

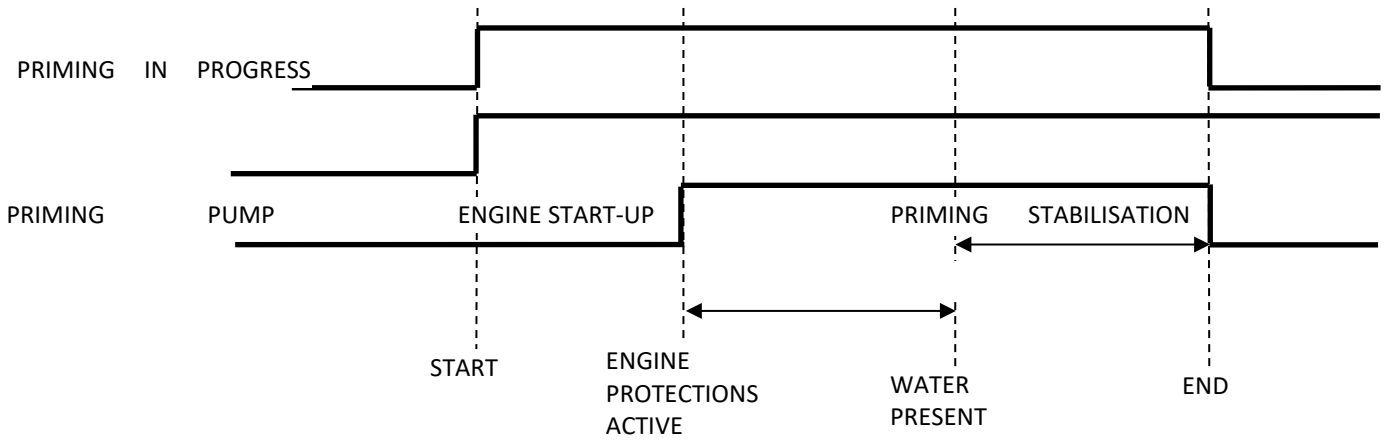

- **PUMP PRIMING WITH WATER ACCUMULATION TANK**

The control unit activates the function-output PUMP PRIMING, to which a solenoid valve must be connected that enables the water to drop from the tank to the pump by gravitational force. It remains in this state for the entire PUMP FILLING TIME, and then starts the diesel engine. When the water level rises and the sensor detects the presence of water, or the pressure read by the TPA-200 exceeds the threshold PRIMING PRESSURE, the control unit waits for the PRIMING STABILISATION, and then deactivates the function-output PUMP PRIMING. If the presence of water is not detected for the PRIMING FAILURE TIME, the fault “**Pump priming failure**” will be generated and the system will be locked out. The function-output PRIMING IN PROGRESS will be active for the duration of the process.

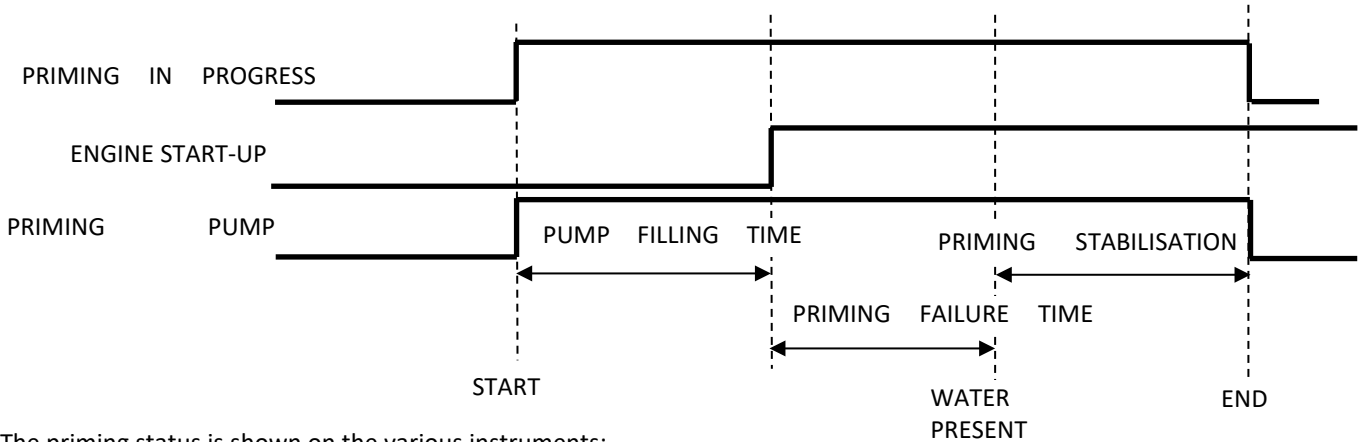

The priming status is shown on the various instruments:



Priming in progress



Pump not Primed



Pump Primed (or disabled)

PIPE FILLING

PIPE FILLING is an automatic function that allows filling the pipes that connect the pump to the irrigation systems with water. This function prevents water from flowing into the irrigation system nozzle with an excessive pressure and causing damage as a result.

During pipe filling, the pump protections do not activate; the only active protection is the “Water pump maximum pressure” fault.

This function is excluded by factory default.

Pipes are filled only if there is a pressure control.

It is not done if the VAR is disabled.

It is done only from AUTOMATIC mode.

It starts with the engine running (protections active) with the pump primed.

There are three pipe filling modes:

- ACCELERATION FILLING

The control unit attempts to reach the working pressure setpoint by gradually accelerating the engine; in mechanical engines the actuator is activated for a time equal to "ACTUATOR ACTIVATION", followed by a pause for a time equal to "ACTUATOR PAUSE"; in electronic engines, on the other hand, the TSC1 rpm setting command is sent to the engine ECU with a value equal to the current value +/- RPM VARIATION STEP, which is followed by a pause equal to RPM VARIATION TIME, and then the pressure is assessed. If there is air in the pipes, there will be very little pressure variation or none at all; in that case, the acceleration will be spaced out with pauses equal to "FILLING PAUSE". When a pressure variation equal to at least "FILLING PRESSURE DELTA", the control unit ramps up the engine acceleration. This cycle will be repeated several times until the working pressure is reached.

If the pressure is not reached within the "PIPE FILLING FAILURE" time, the fault "Pipe Filling Failure" will be triggered and the engine-driven pump will be stopped.

MECHANICAL ENGINES

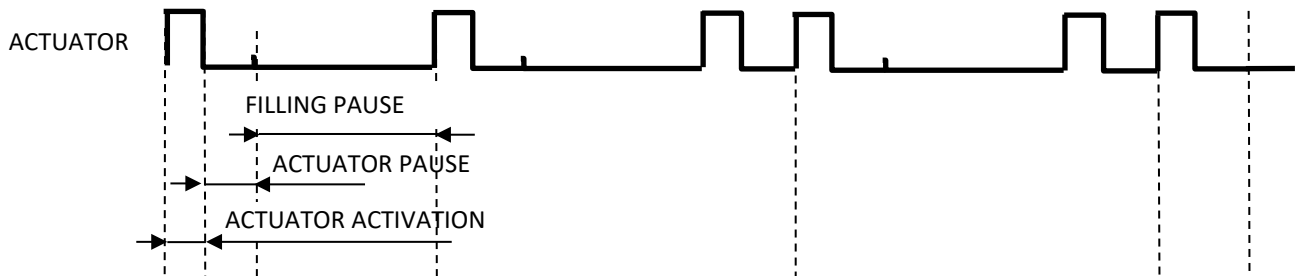

ELECTRONIC ENGINES

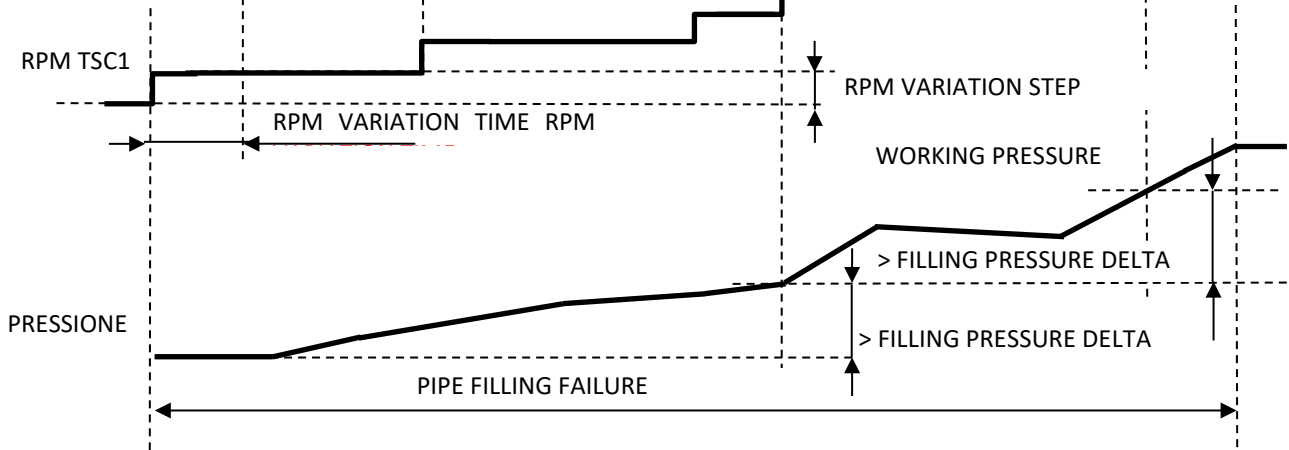

- **CONSTANT SPEED FILLING**

The control unit attempts to reach the working pressure setpoint by bringing the engine rpm to the value of "PIPE FILLING SPEED"; in mechanical engines the actuator is activated for a time equal to "ACTUATOR ACTIVATION", followed by a pause for a time equal to "ACTUATOR PAUSE"; in electronic engines, on the other hand, the TSC1 rpm setting command is sent to the engine ECU with a value equal to the current value +/- RPM VARIATION STEP, which is followed by a pause equal to RPM VARIATION TIME, and then the pressure is assessed. It stays in this state until the pressure reaches the "FILLING END PRESSURE" threshold or until the working pressure is reached. If the pressure is not reached within the "PIPE FILLING FAILURE" time, the fault "Pipe Filling Failure" will be triggered and the engine-driven pump will be stopped.

If the pressure setpoint value or the "FILLING END PRESSURE" value is reached during acceleration, the process ends.

MECHANICAL ENGINES

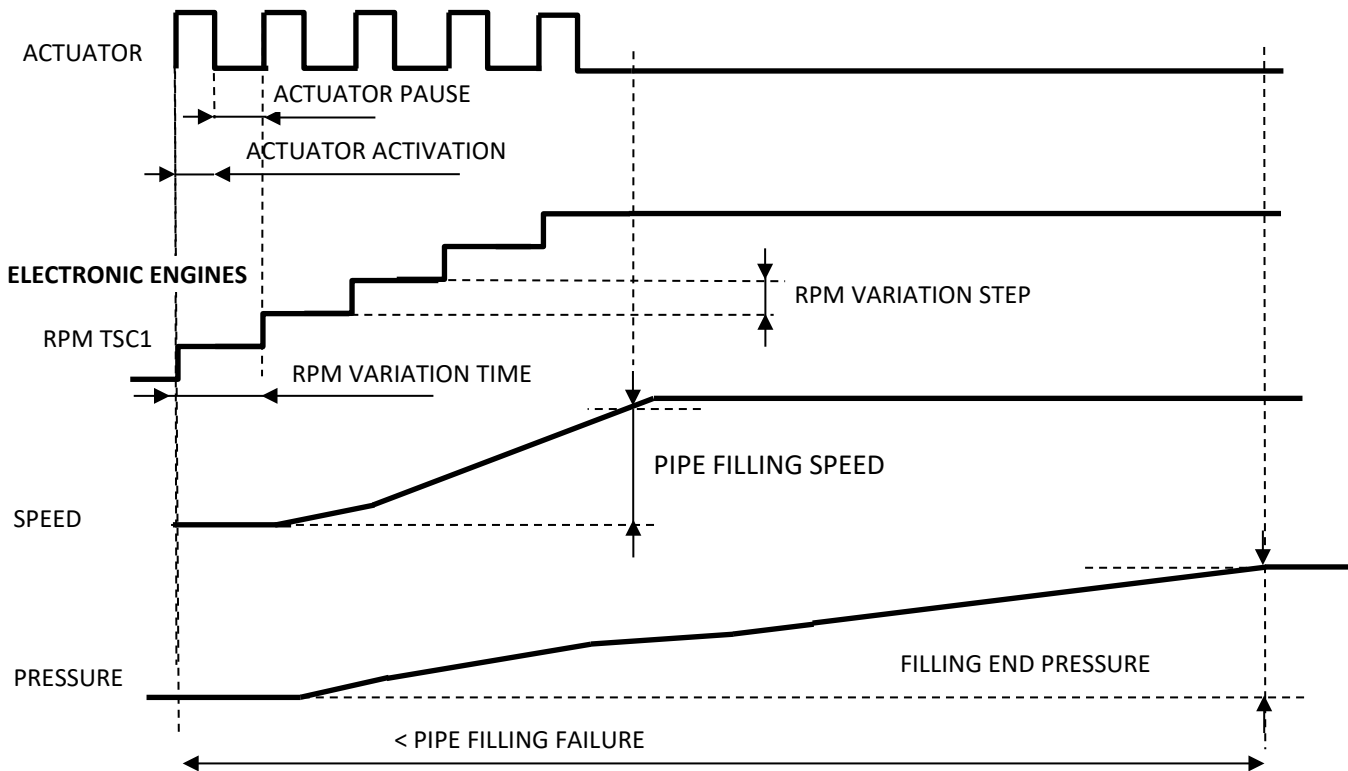

- FILLING WITH VALVE

The function is valid if the system is fitted with motorised delivery valve. The control unit attempts to reach the working pressure setpoint by bringing the engine rpm to the value equal to "PIPE FILLING SPEED"; in mechanical engines the actuator is activated for a time equal to "ACTUATOR ACTIVATION", followed by a pause for a time equal to "ACTUATOR PAUSE"; in electronic engines, on the other hand, the TSC1 rpm setting command is sent to the engine ECU with a value equal to the current value +/- RPM VARIATION STEP which is followed by a pause equal to RPM VARIATION TIME, and then the speed is assessed. Next, the valve is opened with small impulses lasting "VALVE ACTIVATION"; the system waits for a time equal to "VALVE PAUSE" and then verifies the pressure. If the pressure decrease is higher than the "FILLING PRESSURE DELTA" threshold, the movement of the valve is suspended. Opening of the valve will resume after the pressure is restored and if the "VARIATION FAILURE TIME" time has elapsed; if this value is exceeded, the fault "PIPE FILLING FAILURE" is triggered. The cycle keeps going until the pressure reaches the "FILLING END PRESSURE" threshold or until the working pressure is reached; next, the valve is activated for a time equal to "COMPLETE VALVE ACTIVATION" and then released.

If the pressure is not reached within the "PIPE FILLING FAILURE" time, the fault "Pipe Filling Failure" will be triggered and the engine-driven pump will be stopped.

If the setpoint value or the "FILLING END PRESSURE" value is reached during acceleration, the process ends.

During the engine stop, the valve is closed for a time equal to "COMPLETE VALVE ACTIVATION".

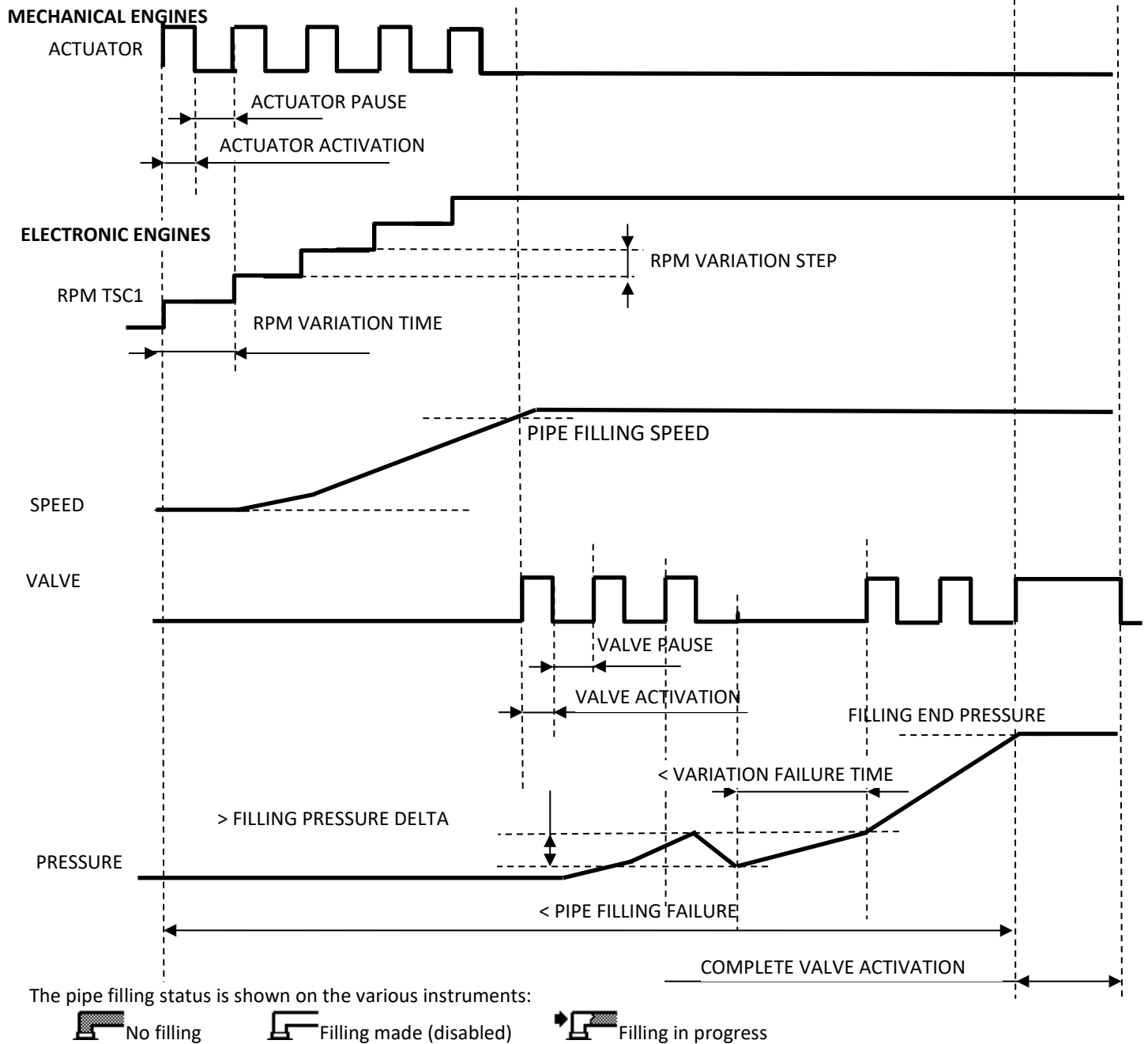

OPERATING MODE

The control unit has the following operating modes:

- **IRRIGATION (factory setting)**

The engine-driven pump operates for irrigation.

- **ANTIFROST**

The engine-driven pump is used in antifrost systems. In this mode, all engine and pump protections do not stop the engine.

All functions are managed ordinarily as for irrigation mode. The faults that trigger a stop are:

EMERGENCY

OVERSPEED

PUMP WATER MAX PRESSURE

MAINTENANCE

To make maintenance to the engine unit as easy as possible, three scheduled maintenance programs – MAINTENANCE – can be set up. When the event occurs, a fault is activated that indicates that the programmed expiry has been reached; these signals cannot be cancelled in the same way as other faults, but must be restored individually.

Programmed expiries can be associated with:

- **RUNNING HOURS:** system's run time (hours).
- **MOTOR HOURS:** engine's run time (hours).
- **CALENDAR:** calendar day.

The message displayed can be personalised.

START-UP

Always as a way to ease maintenance management, the date the system was commissioned can be included under the item:

MAINTENANCE > START-UP

This date is displayed in the section DATA > RETENTION under the settings menus.

PROGRAMMABLE INPUTS

Some digital inputs are fully programmable for activation parameters regarding DELAY TIME and the ACTIVATION LEVELS (active CLOSED or active OPEN); the inputs recognise closing towards the negative pole (ground) The inputs can be addressed to a FUNCTION-INPUT or associated with a FAULT. In the second case, also the TEXT DISPLAYED, ACTIVATION TIME, and STORAGE can be programmed.

If several inputs are associated to a FUNCTION-INPUT, the latter will be active when at least one input is active.

Table of FUNCTION-INPUTS that can be associated:

FUNCTION	DESCRIPTION
"----	No association
PUMP PRESSURE SWITCH	Pressure switch for the water pump; see pump protections
CALL	Starts the pump; see START/STOP
FLOW SWITCH	Flow switch for the irrigation tubing; see START/STOP
FLOAT START	Float switch piloting the start-up; see START/STOP
FLOAT STOP,	Float switch piloting the stop; see START/STOP
FILTER WASH	Indicates filter washing in progress; see pump protections
LOCK	Locking; see START/STOP
FUEL PRESSURE SWITCH	Fuel pressure switch
STANDBY BLOCK	Inhibits the POWER SAVING input
PRESSURE CONTROL	When control is combined and if active, it operates a pressure control.
REGENERATION CONSENT	Enables the input to which an external selector/switch can be connected to signal to the control unit that the safety conditions to be able to perform manual regeneration are met. With the safety conditions enabled it is not possible to start the engine; see fault Attempted to start with safety conditions on
LITERS COUNTER	Enables management of a device to measure the quantity of water dispensed by the pump. It is possible to connect it only to the following inputs: IN PURPLE, IN ORANGE/PURPLE, IN ORANGE/BROWN.
OIL PRESSURE SWITCH	Engine oil pressure pressure switch
ENGINE THERMOSTAT	Engine temperature thermostat
FUEL FINISHED	Manages the no fuel fault via the contact

The table of programmable inputs is given below.

Wire colour
IN ORANGE/BROWN
IN ARANCIO/VIOLA
IN PURPLE
IN BLACK/GREEN
BLACK/BLUE INPUT
WHITE INPUT
SKY BLUE INPUT
ORANGE INPUT

PROGRAMMABLE OUTPUTS

FUNCTION-OUTPUTS and FAULTS can be associated with each programmable output. The output is activated (the corresponding relay is closed) when the FUNCTION-OUTPUT or associated FAULT is active. If several FUNCTION-OUTPUTS or FAULTS are associated with an output, the output will be active when at least one function-output or fault is active.

The table of FUNCTION-OUTPUTS that can be associated is given below.

FUNCTION	Description
"----	No association.
LIGHT	Used to pilot the spotlight.
ENGINE RUNNING	Activates the output and signals that the engine is actually running.
ENGINE DELAYED RUNNING	Indicates, if output is activated, that the engine is actually running and 20 seconds have elapsed (this time cannot be programmed).
STOP WITH ELECTROMAGNET	Management of the engine stop command excited during stopping phase is associated to the output.
STOP IN PROGRESS	Indicates that the control unit is running the stopping procedure. Restores with the engine stopped or with a failed stop condition.
FAULT RESET	Enables the output for 1 second when the operator uses the front buttons to reset the faults.
PUMP PRIMING	Priming pump discharge, see section on pump priming.
PRIMING IN PROGRESS	Active when pump priming is in progress.
CLUTCH	See description CLUTCH
OPERATING POINT REACHED	The operating point (i.e., the setpoint pressure or speed) is within the control range and the control is active.
CONTROL UNIT ON	Active when the control unit is on; deactivated when the control unit enters standby.
RELIEF VALVE	When the pressure exceeds the threshold IN-OUT > RELIEF VALVE > MAXIMUM it is activated; when it falls below the threshold IN-OUT > RELIEF VALVE > MINIMUM, it is deactivated.
PREHEATING	Engine pre-heating/post-heating glow plugs.
GENERAL ALARM	General alarm, active when there is a fault present. Can be silenced.
15/54	15/54 of the starter key, can be used for auxiliaries.
COOLING FAN	Used to pilot the COOLING FAN. It is activated when the engine is running and remains active for a settable time after the engine has stopped. See ENGINE > COOLING FAN > DELAY.

The table of programmable outputs is given below.

Wire colour
WHITE/BLUE WIRE
YELLOW/BLUE WIRE
YELLOW/WHITE WIRE
BROWN/WHITE WIRE
BROWN WIRE
RED/GREEN WIRE

FAULTS

FAULT	SOURCE	ACTIVATION	MEMORY	STOP	WITH DECELERATIO	WITH COOLING	Occurs when:
----	-	-	-	-	-	-	Unlinked fault
LOW OIL PRESSURE < Low engine oil pressure >	CONTACT OIL PRESSURE SWITCH	ENGINE PROTECTIONS ACTIVE	YES	YES	NO	NO	The oil pressure is lower than the pressure switch threshold and its contact is closed to ground.
OIL PRESSURE SWITCH FAULT < Oil pressure switch fault		WITH ENGINE STOPPED	YES	YES	NO	NO	The contact is open with engine stopped (the function can be disabled); this allows checking the integrity of the connection.
ENGINE OVERTEMPERATURE < Engine overtemperature by thermostat >	CONTACT THERMOSTAT	ENGINE PROTECTIONS ACTIVE	YES	YES	YES	YES	The temperature is higher than the thermostat threshold and its contact is closed to ground.
OVERTEMPERATURE WARNING < Engine overtemperature warning >	TEMPERATURE TRANSMITTER OR CAN BUS	ALWAYS ACTIVE	YES	PRG	YES	YES	The temperature has exceeded the set threshold.
TEMPERATURE TX INTERRUPTED < Engine temperature transmitter disconnected >	TEMPERATURE TRANSMITTER	ALWAYS ACTIVE	NO	NO	-	-	The temperature transmitter is interrupted or malfunctioning.
INCORRECT TEMP. TABLE < Incorrect temp. transmitter calibration table >	-	ALWAYS ACTIVE	YES	NO	-	-	The CUSTOM engine temperature transmitter calibration table is incorrect.
LOW OIL PRESS. WARN. < Low oil pressure warning >	OIL PRESSURE TRANSMITTER OR CAN BUS	ENGINE PROTECTIONS ACTIVE	NO	PRG	NO	NO	The oil pressure is lower than the set cut-in time threshold.
PRESSURE TX INTERRUPTED < Oil pressure transmitter disconnected	OIL PRESSURE TRANSMITTER	ALWAYS ACTIVE	NO	NO	-	-	The engine pressure transmitter is interrupted or malfunctioning.

INCORRECT PRESSURE TABLE < Incorrect pressure transmitter calibration table >	-	ALWAYS ACTIVE	YES	NO	-	-	The CUSTOM oil pressure transmitter calibration table is incorrect.
LOW FUEL PRESSURE < Low fuel pressure >	FUEL PRESSURE SWITCH	ENGINE PROTECTIONS ACTIVE	YES	YES	NO	NO	The fuel pressure is lower than the pressure switch threshold and the contact is closed to ground (function-input FUEL PRESSURE SWITCH)
FUEL FLOAT TRANSM. FAULT < Fuel float connection disconnected>	FUEL FLOAT	ALWAYS ACTIVE	NO	NO	-	-	The fuel level transmitter is interrupted.
FUEL RESERVE < Fuel reserve >		ALWAYS ACTIVE	NO	NO	-	-	The fuel level is lower than the set threshold. Resets when the level rises above 2% of the threshold.
FUEL FINISHED < Fuel finished>		ALWAYS ACTIVE	YES	PRG	YES	YES	Two simultaneous operations: -The fuel level is lower than the set threshold for the programmed range. -The ORANGE input (FUEL FLOAT SWITCH) is closed to ground.
INCORRECT FLOAT TABLE < Incorrect fuel float calibration table>	-	ALWAYS ACTIVE	YES	NO	-	-	The CUSTOM fuel float calibration table is incorrect.
COOLANT LEVEL < Low coolant level>	RADIATOR LEVEL	ALWAYS ACTIVE	YES	YES	YES	NO	The coolant has dropped below the minimum level.
ALTERNATOR FAULT < Charging alternator fault >	ALTERNATOR	ENGINE PROTECTIONS ACTIVE	YES	PRG	YES	YES	The alternator is not charging the battery or problem in the electrical system.
EMERGENCY < Emergency engine stop>	EMERGENCY BUTTON	ALWAYS ACTIVE	YES	YES	NO	NO	The emergency button is pressed.
ORANGE/BROWN INPUT FAULT PURPLE/ORANGE WIRE PURPLE INPUT FAULT BLACK/GREEN INPUT FAULT FAULT IN BLACK/BLUE	CORRESPONDING INPUT	PRG	PRG	PRG	PRG	PRG	See PROGRAMMABLE INPUTS.
BATTERY UNDERVOLTAGE < Battery undervoltage >	BATTERY	ALWAYS ACTIVE	YES	PRG	YES	YES	The battery voltage is lower than the set threshold for the programmed time.
BATTERY OVERVOLTAGE <Battery overvoltage>		ALWAYS ACTIVE	YES	PRG	YES	YES	The battery voltage is higher than the set threshold for the time programmed.
FAILURE TO STOP < Failure of engine to stop >	SOLENOID VALVE OR ELECTROMAGNET	STOPPING PROCEDURE TERMINATED	YES	YES	-	-	Engine running is detected after the stopping system remained activated for the time ENGINE > STOP > FAILURE TO STOP
UNDERSPEED < Engine underspeed >	ALTERNATOR "W"	WHEN THRESHOLD REACHED	YES	PRG	NO	NO	The engine speed is lower than the set threshold.
OVERSPEED < Engine overspeed >		ALWAYS ACTIVE	YES	PRG	NO	NO	The engine speed is higher than the set threshold.
MAINTENANCE 1 MAINTENANCE 2 MAINTENANCE 3	SETTINGS	ALWAYS ACTIVE	YES	NO	-	-	See settings
KEYBOARD ERRO < Keyboard error >	-	IGNITION	YES	NO	-	-	Buttons were pressed in the ignition phase.
NON-VOLATILE MEMORY ERROR < Non-volatile memory error >	-	ALWAYS ACTIVE	YES	NO	-	-	The non-volatile memory has a fault. To restore the error, switch the control unit off and on.
FAILURE TO START < Failure of engine to start >	-	STARTING PROCEDURE TERMINATED	YES	YES	NO	NO	The engine did not start up: -After a manual start-up -After a number of automatic start-up attempts equal to ENGINE > START > START ATTEMPTS
PUMP WATER UNDERPRESSURE < Water pump underpressure >	TPA-200	PUMP PROTECTIONS ACTIVE	YES	YES	YES	YES	See section PUMP PROTECTIONS.
PUMP WATER OVERPRESSURE < Water pump overpressure >		PUMP PROTECTIONS ACTIVE	YES	YES	YES	YES	
PUMP WATER MAX PRESSURE < Water pump maximum pressure >		ALWAYS ACTIVE	YES	YES	NO	NO	

PUMP WATER PRESS. TX FAULT < Water pump pressure transmitter fault >		ALWAYS ACTIVE	NO	YES	YES	NO	The values read by the transmitter are not consistent with the specifications. The transmitter could be disconnected or malfunctioning. See section PUMP PROTECTIONS.
PUMP PRESS. UNDERPRESSURE < Underpressure by pump pressure switch >	PUMP PRESSURE SWITCH	PUMP PROTECTIONS ACTIVE	YES	YES	YES	YES	See section PUMP PROTECTIONS.
YELLOW/BLUE WIRE FAULT YELLOW/WHITE WIRE FAULT < Yellow / Blue wire output anomaly > < Yellow / Blue wire output anomaly >	OUTPUTS	ALWAYS ACTIVE	NO	NO	-	-	There is an overload or short-circuit problem on the corresponding output
NO SIM CARD < NO SIM CARD >	MODEM OPTION	ACTIVE MODEM	YES	NO	-	-	No SIM card in the control unit.
SIM CARD WITH ACTIVE PIN < SIM CARD with pin active >		ACTIVE MODEM	YES	NO	-	-	SIM card PIN was not deactivated.
NO NUMBER IN CONTACTS < No telephone number in contacts >		ACTIVE SMS MESSAGES	YES	NO	-	-	No telephone number in the phone book for SMS text messaging
NO APN < No APN entered >		ACTIVE IOT	YES	NO	-	-	No APN set up for app connectivity.
GENERIC MODEM ERROR < Generic MODEM error >		ACTIVE MODEM	YES	NO	-	-	A generic modem error has occurred. The Modem instrument can provide more detailed information.
FUEL FAULT < Fuel fault >		ACTIVE MODEM and SENT COMMAND	YES	YES	NO	-	See description for FUEL FAULT.
PRIMING FAILURE < Pump priming failure >		PROCESS PUMP PRIMING	PROCESS PUMP PRIMING	YES	YES	YES	NO
PIPE FILLING FAILURE < Pipe Filling Failure >	PROCESS PIPE FILLING	PROCESS PIPE FILLING	YES	YES	YES	NO	See PIPE FILLING
ACCELERATION FAULT < Acceleration Fault >	-	PRESSURE CONTROL PROCESS	YES	YES	YES	NO	See AUTOMATIC IRRIGATION MODE
ADJUSTMENT ERROR < Adjustment error >	-	PRESSURE CONTROL PROCESS	YES	YES	YES	YES	See AUTOMATIC ADJUSTMENT MODE
ENGINE RPM FAULT < Engine RPM fault >		ENGINE PROTECTIONS ACTIVE	YES	NO	-	-	Engine rpm changed without control unit intervention (VAR).
CAN BUS < CAN BUS communication error >	ENGINE ECU CONNECTION	CAN BUS ATTIVO	NO	YES	NO	NO	The control uni is not communicating correctly with the ENGINE ECU
Warning overtemperature detected by the ECU < ECU WARNING OVERTEMPERATURE >	ENGINE ECU CONNECTION	CAN BUS ACTIVE ENGINE PROTECTIONS ACTIVE	YES	PRG	YES	YES	Engine overtemperature pre-alarm sent by the engine ECU. Active fault only for Stage V engines.
Overtemperature detected by the ECU < ECU OVERTEMPERATURE >	ENGINE ECU CONNECTION	CAN BUS ACTIVE ENGINE PROTECTIONS ACTIVE	YES	YES	YES	YES	Engine overtemperature error sent by the engine ECU. Active fault only for Stage V engines.
Low oil pressure detected by the ECU < ECU LOW OIL PRESSURE >	ENGINE ECU CONNECTION	CAN BUS ACTIVE ENGINE PROTECTIONS ACTIVE	YES	YES	NO	NO	Low oil pressure error sent by the engine ECU. Active fault only for Stage V engines.
Vacuum transducer interrupted < VACUUM TX INTERRUPTED >	DELIVERY VACUUM SENSOR	ALWAYS ACTIVE	NO	NO	-	-	See cavitation description.
Pump cavitation pre-alarm < CAVITATION PRE-ALARM >		PUMP PROTECTIONS ACTIVE	NO	NO	-	-	
Pump cavitation alarm < CAVITATION ALARM >		PUMP PROTECTIONS ACTIVE	YES	YES	YES	YES	

Work hours threshold in cavitation exceeded < EXCESSIVE CAVITATION TIME >		ALWAYS ACTIVE	YES	NO	-	-	
Attempted to start with safety conditions on < START WITH SAFETY ON >	CORRESPONDING INPUT	ALWAYS ACTIVE	NO	YES	NO	NO	Fault managed only if the input function REGENERATION CONSENT is programmed. The control unit signals the fault if an attempt is made to start the engine with safety conditions enabled. In order to be able to start the engine, it will be necessary to remove the safety conditions and then enable them with the engine running, when it is necessary to perform manual regeneration
Engine stop by ECU < ECU ENGINE STOP >	ENGINE ECU CONNECTION	ALWAYS ACTIVE	YES	YES	NO	NO	Stop request transmitted by engine ECU. Active fault only for Stage V engines.

SERIAL PORTS

The control unit includes USB 2.0 port. It is detected as VCP (Virtual COM Port) and can be connected to a PC to:

- Transfer settings using SW ZW-SMART
- Update the control unit's FW using SW ZW-UPG
- Querying with protocol MOD Bus RTU

CONNECTION DIAGRAM

See following pages.

WIRING DIAGRAM

WIRING DIAGRAM STOP SOLENOID VALVE

CABLE LENGHT 2,8m

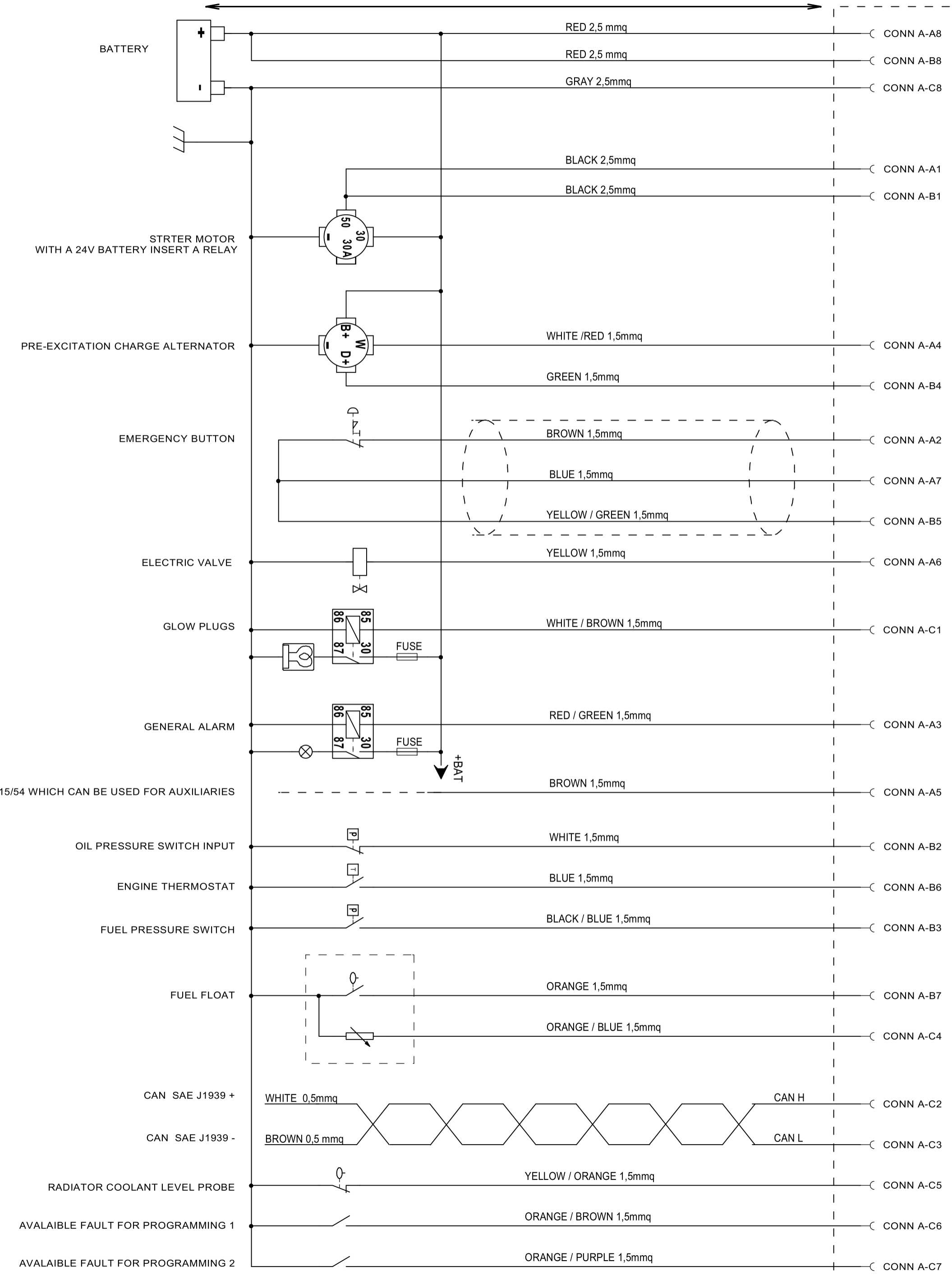

CONNECTOR "A" BLACK

Basic scheme subject to change without notice.

WIRING DIAGRAM

WIRING DIAGRAM WITH STOP ELECTRO-MAGNET

CABLE LENGTH 2,8m

CONNECTOR "A" BLACK

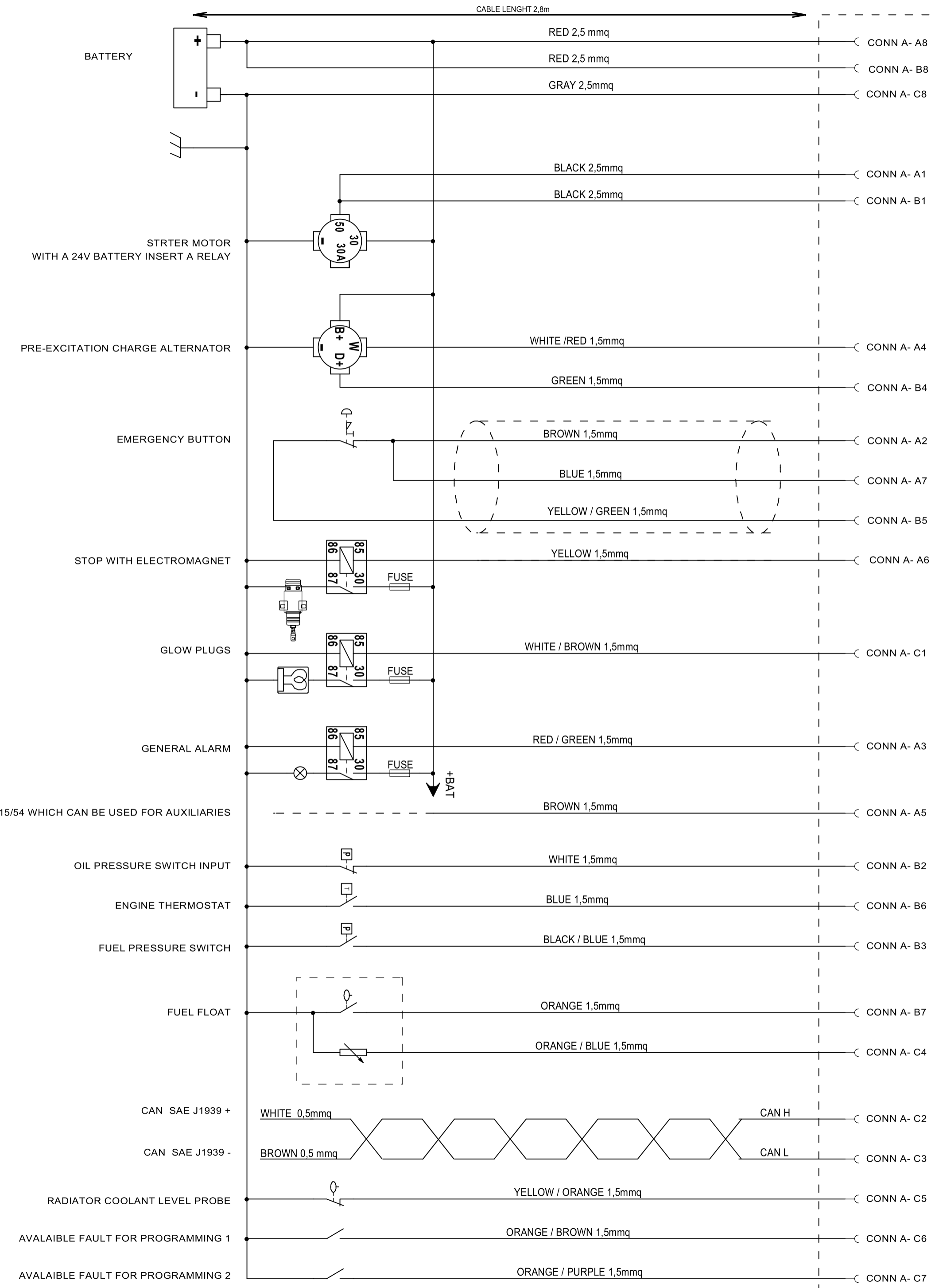

Basic scheme subject to change without notice.

WIRING DIAGRAM

DIAGRAM WITH PERMANENT MAGNETS CHARGE ALTERNATOR

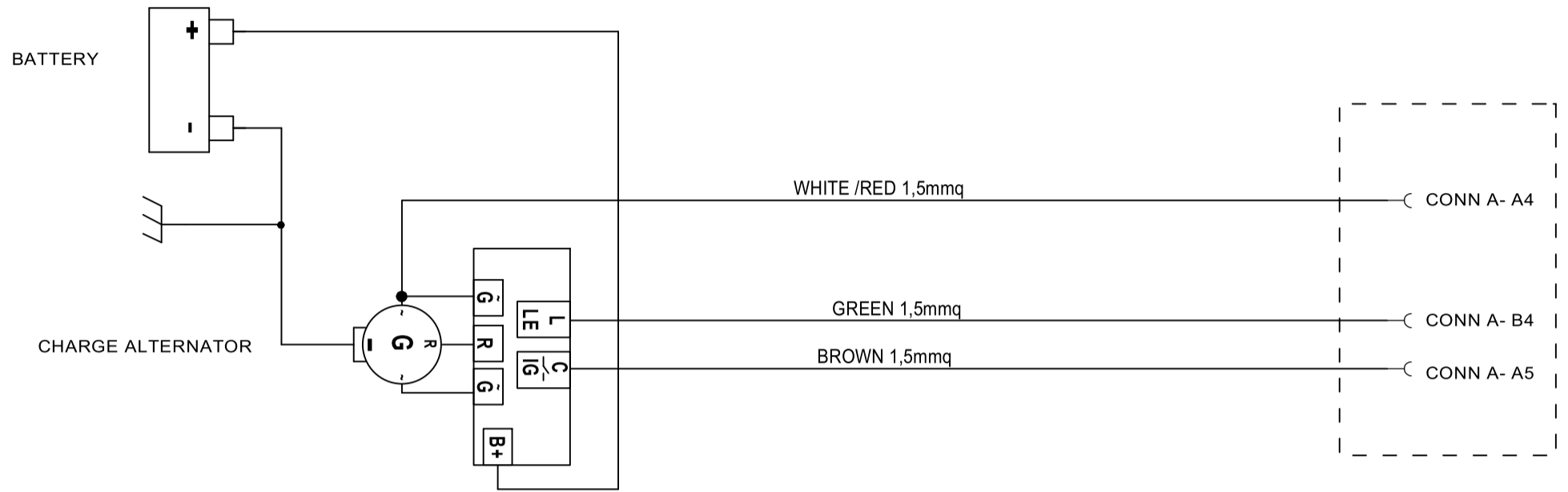

CONNECTOR "A" BLACK

WIRING DIAGRAM

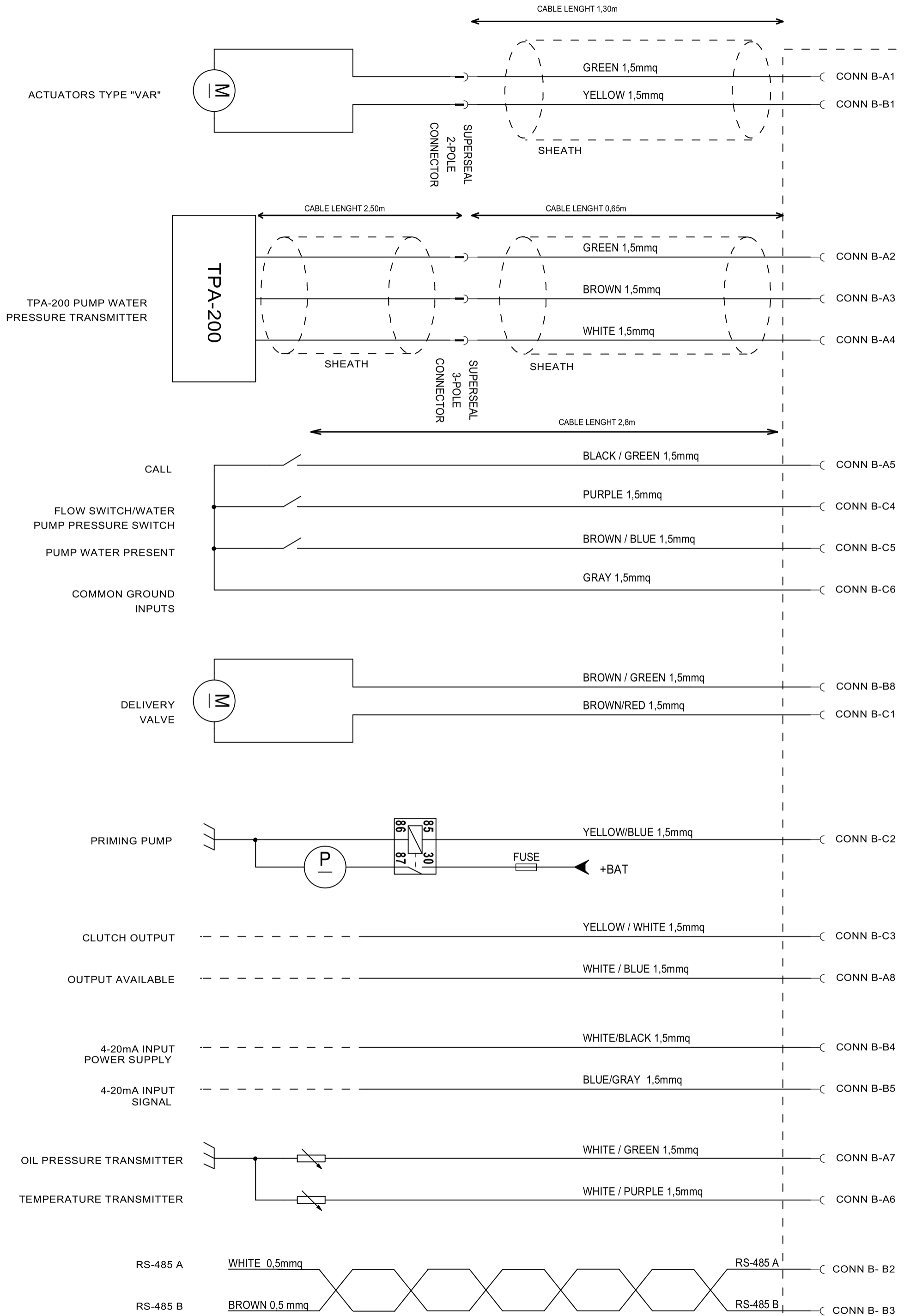

CONNECTOR PINOUTS

BLACK connector.

<i>Pin</i>	<i>CSA mm²</i>	<i>Colour</i>	<i>Description</i>	<i>IN/OUT control unit side</i>	<i>Notes</i>
A1	2.5	BLACK	STARTING	OUTPUT +	Connect to terminal 50 of the starter motor in parallel with the black wire B1.
A2	1.5	BROWN	POSITIVE EMERGENCY	OUTPUT +	Connect to the NC contact of the emergency button.
A3	1.5	RED/GREEN	GENERAL ALARM	OUTPUT +	Collect to the coil of the general alarm relay.
A4	1.5	WHITE/RED	TACHOMETER	INPUT ~	Connect to the "W" of the charging alternator.
A5	1.5	BROWN	15/54	OUTPUT +	Simulates the 15/54 of a starter key.
A6	1.5	YELLOW	STOP	OUTPUT +	Connect to the fuel solenoid valve or to the coil of the stop electromagnet, or to the ECU ignition.
A7	1.5	BLUE	POWER EMERGENCY	INPUT +	Connect to the NC contact of the emergency button. Join to yellow/green wire B5.
A8	2.5	RED	POSITIVE POWER SUPPLY	POWER SUPPLY +	Connect to the positive pole of the battery in parallel with the red wire B8.
B1	2.5	BLACK	STARTING	OUTPUT +	Connect to terminal 50 of the starter motor in parallel with the black wire A1.
B2	1.5	WHITE	OIL PRESSURE SWITCH	INPUT -	Connect to the engine oil pressure switch.
B3	1.5	BLACK/BLUE	FUEL PRESSURE SWITCH	INPUT -	Connect to the fuel pressure switch.
B4	1.5	GREEN	ALTERNATOR CHARGE SIGNAL	INPUT	Connect to the "D+" of the charging alternator.
B5	1.5	YELLOW/GREEN	SIGNAL EMERGENCY	INPUT +	Connect to the NC contact of the emergency button. Join to blue wire A7.
B6	1.5	BLUE	ENGINE THERMOSTAT	INPUT -	Connect to the engine thermostat.
B7	1.5	ORANGE	FUEL RESERVE	INPUT -	Connect to the fuel float contact.
B8	2.5	RED	POSITIVE POWER SUPPLY	POWER SUPPLY +	Connect to the positive pole of the battery in parallel with the red wire A8.
C1	2.5	WHITE/BROWN	GLOW PLUGS	OUTPUT +	Collect to the coil of the spark plugs relay.
C2	1.5	WHITE	CAN H	DATA	Screened twisted-pair cable to connect to the ECU CAN line.
C3	1.5	BROWN	CAN L		
C4	1.5	ORANGE/BLUE	FUEL FLOAT	ANALOGUE INPUT	Connect to the variable resistor of the fuel float.
C5	1.5	ORANGE/YELLOW	RADIATOR COOLANT PRESENCE	INPUT -	Connect to the coolant presence sensor in the radiator.
C6	1.5	ORANGE/BROWN	AVAILABLE ANOMALY 1	INPUT -	Connect to any fault contact.
C7	1.5	ORANGE/PURPLE	AVAILABLE ANOMALY 2	INPUT -	Connect to any fault contact.
C8	2.5	GREY	NEGATIVE POWER SUPPLY	POWER SUPPLY -	Connect to the negative pole of the battery.

GREY connector.

<i>Pin</i>	<i>CSA mm²</i>	<i>Colour</i>	<i>Description</i>	<i>IN/OUT control unit side</i>	<i>Notes</i>
A1	1.5	GREEN	ACCELERATE THE ENGINE RPM	OUTPUT +/-	Connect to the linear actuator for engine acceleration and deceleration. In combination with B1.
A2	1.5	GREEN	PRESSURE TRANSDUCER GND	OUTPUT +	Connect to the TPA-200.
A3	1.5	BROWN	PRESSURE TRANSDUCER VDC	OUTPUT -	
A4	1.5	WHITE	PRESSURE TRANSDUCER SIGNAL	ANALOGUE INPUT	
A5	1.5	BLACK/GREEN	REMOTE START-UP	INPUT -	Connect to the remote starting NO contact.
A6	1.5	WHITE/PURPLE	ENGINE TEMPERATURE TRANSMITTER	ANALOGUE INPUT	Connect to the engine temperature ohmic transmitter.
A7	1.5	WHITE/GREEN	ENGINE OIL PRESSURE TRANSMITTER	ANALOGUE INPUT	Connect to the engine oil pressure ohmic transmitter.
A8	1.5	WHITE/BLUE	SPARE	OUTPUT +	Spare output.
B1	1.5	YELLOW	DECELERATE THE ENGINE RPM	OUTPUT +/-	Connect to the linear actuator for engine acceleration and deceleration. In combination with A1.
B2	1.5	WHITE	RS485 A	DATA	Screened twisted-pair cable. Data transmission line.
B3	1.5	BROWN	RS485 B		
B4	1.5	WHITE/BLACK	4-20mA	OUTPUT +	Connect to the 4-20mA transducer.
B5	1.5	BLUE/GREY	4-20mA	ANALOGUE INPUT	
B6					
B7					
B8	1.5	BROWN/GREEN	DELIVERY VALVE	OUTPUT +/-	Connect to the starter motor of the motorised valve at the pump outlet.
C1	1.5	BROWN/RED	DELIVERY VALVE		
C2	1.5	YELLOW/BLUE	PRIMING PUMP	OUTPUT +	Collect to the coil of the priming pump relay.
C3	1.5	WHITE/YELLOW	CLUTCH	OUTPUT +	Connect to the clutch management circuit.
C4	1.5	PURPLE	FLOW SWITCH	INPUT -	Connect to the water pressure or flow switch contact.
C5	1.5	BROWN/BLUE	WATER IN PUMP PRESENCE	INPUT -	Connect to the water in pump presence sensor.
C6	1.5	GREY	AUXILIARIES GND	OUTPUT -	Digital inputs common.
C7					
C8					

SETTINGS

To access settings (the pump must be stopped), go to the <<PROG>> instrument (CLOCK instrument, then press UP_BUTTON), and then hold down the CONFIRM_BUTTON until OK! is displayed. During settings, the PUMP_PROTECTIONS_DISABLED_LED emits two quick flashes.



To move between the menus, use the UP_BUTTON, DOWN_BUTTON, LEFT_BUTTON, RIGHT_BUTTON and select the parameter to be displayed or modified with the RIGHT_BUTTON.

After period of time in settings without any activity, the control unit returns to the operating mode on its own. To exit settings, go to the start menu and hold down the CONFIRM_BUTTON until OK! appears:



SETTING TYPES

There are multiple types of settings available:

MULTIPLE CHOICE

This allows one parameter to be selected from many, for example the language. The set parameter is the one with the black dot next to it; the selection can be changed using the UP_BUTTON and DOWN_BUTTON.

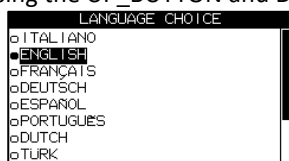

To confirm the parameter, press the CONFIRM_BUTTON until OK is displayed.



To exit settings, press the LEFT_BUTTON or CONFIRM_BUTTON.

PASSWORD

Access to some menus, or setting of some parameters, requires the entry of a numerical password:



Enter one digit at a time; use the LEFT_BUTTON and RIGHT_BUTTON to move the cursor, and the UP_BUTTON and DOWN_BUTTON to change the digit. To test, use the CONFIRM_BUTTON until the result appears:

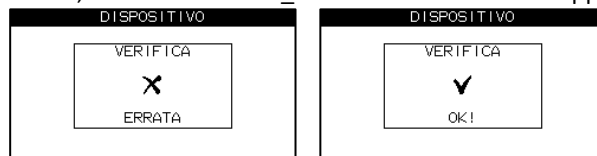

It is possible to change the password in the same manner; the existing password must be entered first.

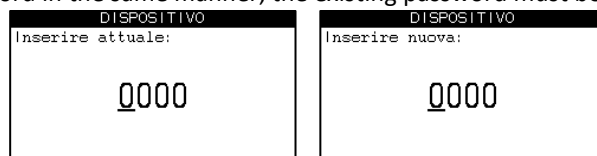

To exit settings, press the PUMP_PROTECTIONS_DISABLE_BUTTON.

CLOCK/CALENDAR

The current time and date are displayed:



The value shown can be changed using the UP_BUTTON or DOWN_BUTTON. To change selection, use the RIGHT_BUTTON or the LEFT_BUTTON. To exit settings, press the PUMP_PROTECTIONS_DISABLE_BUTTON. It does not require confirmation. The time is retained by the control unit even when it is not powered, thanks to an internal battery.

If the internal battery is not installed, the following date and time will appear on start-up: 1/01/2020, 00:00.00.

EXCLUSION

A parameter can be enabled or disabled; use the UP_BUTTON or DOWN_BUTTON to change the setting. If the parameter is modified, the text is highlighted.



To set it, press the CONFIRM_BUTTON until OK is displayed. To exit programming, press the LEFT_BUTTON or PUMP_PROTECTIONS_DISABLE_BUTTON.

VALUE

The settings screen displays the value of the parameter in the centre (highlighted if modified), the unit of measurement at the bottom right, and the details and quantitative indication of the value on the left:

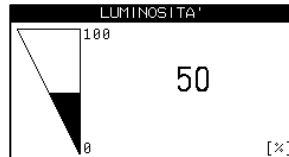

Use the UP_BUTTON or DOWN_BUTTON to modify the value and the CONFIRM_BUTTON to confirm the value:

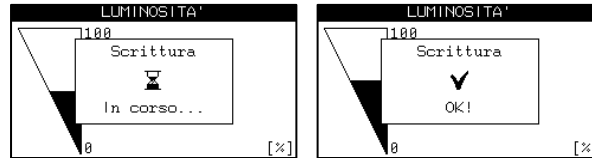

To exit programming, press the LEFT_BUTTON or PUMP_PROTECTIONS_DISABLE_BUTTON. Normally, the set value takes effect only after OK! is displayed. In some settings, the value is modified instantly and retained only if confirmed: an example of this is the LCD contrast setting.

TEXT STRING SETTINGS

The text to be modified is displayed at the centre, and the available number of characters at the bottom right. The cursor indicates the character being edited. Use the LEFT_BUTTON and RIGHT_BUTTON to move the cursor, and the UP_BUTTON and DOWN_BUTTON to change the character.

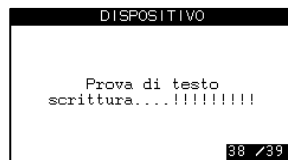

To set it, press the CONFIRM_BUTTON until OK is displayed.

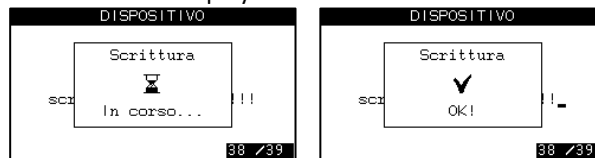

To exit programming, press the LEFT_BUTTON or PUMP_PROTECTIONS_DISABLE_BUTTON.

TABLE SETTINGS

In some cases table values must be set, for example for the fuel float sensor. The values are represented in two columns:

LIVELLO COMBUSTIBILE	
0	% ---
10	% ---
20	% ---
30	% ---
40	% ---
50	% ---
60	% ---
70	% ---

The element being modified is highlighted and flashes. Use the RIGHT_BUTTON to increase the value and the LEFT_BUTTON to decrease it; once the value has been modified, two dots are displayed beside it. To set the entire table, press the CONFIRM_BUTTON until OK is displayed:

LIVELLO COMBUSTIBILE	
• 10	% 26 Ω •
• 20	% 40 Ω •
• 30	% ---
• 40	% ---
• 50	% 146 Ω •
• 60	% ---
• 70	% 156 Ω •
• 80	% ---

LIVELLO COMBUSTIBILE	
• 10	% 26 Ω •
• 20	% 40 Ω •
• 30	% ---
• 40	% ---
• 50	% 146 Ω •
• 60	% ---
• 70	% 156 Ω •
• 80	% ---

LIVELLO COMBUSTIBILE	
• 10	% 26 Ω •
• 20	% 40 Ω •
• 30	% ---
• 40	% ---
• 50	% 146 Ω •
• 60	% ---
• 70	% 156 Ω •
• 80	% ---

To exit programming, press the LEFT_BUTTON or PUMP_PROTECTIONS_DISABLE_BUTTON.

TIME

Times can be modified in the format hours/minutes. Two examples follow:

ESEMPIO ore:min	
107h 02'	

Use the LEFT_BUTTON and RIGHT_BUTTON to move the selection (flashing value with cursor), the UP_BUTTON and DOWN_BUTTON to change the value. To set, press the CONFIRM_BUTTON until OK is displayed:

ESEMPIO ore:min	
Scrittura ⌚ In corso...	

ESEMPIO ore:min	
Scrittura ✓ OK!	

CONFIRM ACTION

Some settings require confirmation; for example FACTORY SETTINGS RESET or DELETE LOG action:

CANCELLARE STORICO	
cancella storico eventi. -Tasto [CONFERMA]-	

To confirm, press the CONFIRM_BUTTON until OK is displayed:

CANCELLARE STORICO	
canc	Scrittura ⌚ In corso... anti.

CANCELLARE STORICO	
canc	Scrittura ✓ OK! anti.

SPECIAL CASES

There are some special types of settings (for example, rpm calibration); please see the instructions on the display.

SETTINGS SW

Using the ZW-SMART Software, the control unit can be programmed over the USB Virtual Com Port.

PARAMETER SETTINGS

LANGUAGE CHOICE

Parameter	Factory settings	Range	Notes
LANGUAGE	ITALIANO	ITALIANO	Resetting the language overwrites programmable fault text and maintenance operation text with the default language value. A CUSTOM language cannot be selected unless the messages have been programmed with the ZW-SMART software.
		ENGLISH	
		FRANÇAIS	
		DEUTSCH	
		ESPAÑOL	
		PORTUGUÊS	
		CUSTOM	

DATA

Page	Description	Example
RELEASE HW	Device's main ID.	<pre> RELEASE HW ----- HW Code: _____40332627 Board: _____ 0.01 Assembly: _____0.01 </pre>
RELEASE MODEM	Modem card ID.	<pre> RELEASE MODEM ----- HW Code: _____40332629 Board: _____ 0.01 Assembly: _____0.01 </pre>
RELEASE FW	Device's FW ID.	<pre> RELEASE FW ----- FW Code: _____0x4023 Boot: _____ 1-00 App: _____ 0-06 </pre>
INFO	Device information	<pre> INFO ----- s.n.: _____ 1 Type: _____Model--- Mat: _____Matr.--- </pre>
PRODUCTION	Production information	<pre> PRODUZIONE ----- Coll: _____00/2000 Time: _____ 48:00 Box: _____ 00 </pre>
DEVICE	Device life information	<pre> DISPOSITIVO ----- Time: _____ 123h52'57s Switch ON: _____2255 </pre>
RETENTION	System operation information	<pre> RETENTION ----- Ore Totali: _____3:01 Avviamenti: _____21 Mancati avv.: _____7 Avvio: _____00/00/2000 </pre>
APP	App connection information	<pre> APP ----- s.n.: __0001641900000001 Code: _____ 16419 Type: _____CEM-190 </pre>

CALENDAR CLOCK

Parameter	Variable	Factory settings	Range	Notes
CALENDAR CLOCK	DATE AND TIME		...	Clock/calendar settings.
	FORMAT	ANALOGUE	ANALOGUE DIGITAL	

BATTERY				
Parameter	Variable	Factory settings	Range	Notes
ENTER PASSWORD		"0000"	"0000" – "9999"	Entering the correct password allows the parameters to be changed.
CHANGE PASSWORD		"0000"	"0000" – "9999"	Change the password for access to the menu.
BATTERY VOLTMETER		INCLUDED	INCLUDED	Displays the starting battery voltage measured between the RED and GREY wires. If disabled, faults "FAULT _ BATTERY UNDERVOLTAGE" and "Battery overvoltage" are not active.
			EXCLUDED	
BATTERY VOLTAGE		12 V	12 V	Nominal battery voltage; by setting a new value, the thresholds and delays of BATTERY UNDERVOLTAGE , BATTERY OVERVOLTAGE and ENGINE > ALTERNATOR CHARGE > ALTERNATOR D+ > ENGINE RUNNING D+ are reset to the default values.
			24 V	
BATTERY UNDERVOLTAGE	FAULT	INCLUDED	INCLUDED	See fault.
			EXCLUDED	
	THRESHOLD	11 V [12 V] 22 V [24 V]	8 ÷ 14 V [12 V] 16 ÷ 28 V [24 V]	
	DELAY	2 s	(1 ÷ 5) s	
STOP	WITHOUT STOP	WITHOUT STOP	WITH STOP	
BATTERY OVERVOLTAGE	FAULT	INCLUDED	INCLUDED	See fault.
			EXCLUDED	
	THRESHOLD	16 V [12 V] 32 V [24 V]	12 ÷ 18 V [12 V] 24 ÷ 36 V [24 V]	
	DELAY	2 s	(1 ÷ 5) s	
STOP	WITHOUT STOP	WITHOUT STOP	WITH STOP	

ENGINE					
Parameter	Variable	Factory settings	Range	Notes	
ENTER PASSWORD		"0000"	"0000" – "9999"	Entering the correct password allows the parameters to be changed.	
CHANGE PASSWORD		"0000"	"0000" – "9999"	Change the password for access to the menu.	
ENGINE PROTECTION DELAY		20 s	(5 ÷ 60) s	Engine protection activation delay after engine running detected.	
ENGINE RPM FAULT	FUNCTION	INCLUDED	INCLUDED	See fault description.	
	THRESHOLD		100 RPM		(50 ÷ 1000) RPM
STOP	STOP SYSTEM	ENERGIZED IN RUN. MODE	ENERGIZED IN RUN. MODE	Fuel supply system.	
			ENERGIZED IN STOP MODE		
	STOP TIME	20 s	(0 ÷ 60) s	Stopping system activation time with engine at a standstill.	
	FAILURE TO STOP	120 s	(0 ÷ 120) s	See STOPPING FAILURE fault.	
START	START TIME	5 s	(5 ÷ 25) s	Starter motor activation time.	
	PAUSE TIME	5 s	(5 ÷ 10) s	Pause between start-up attempts.	
	START ATTEMPTS	4	(1 ÷ 15)	See START-UP FAILURE fault	
GLOW PLUGS	PREHEATING	0 s	(0 ÷ 60) s	Activated before start-up. 0 sec, pre-heating off. Too long a time can damage the glow plugs.	
	POST-HEATING	0 s	(0 ÷ 60) s	Enabled throughout engine start-up and for the set time. 0 sec, post-heating off.	
DECELERATION	RPM VARIATION STEP	20 rpm	(5 ÷ 500) rpm	Available only for electronic engines. Regulate the deceleration ramp speed.	
	RPM VARIATION TIME	60 ms	(20 ÷ 2000) ms		
OIL PRESSURE CHECK		BEFORE STARTING	ENGINE RUNNING	The OIL PRESSURE SWITCH FAULT is disabled and the LOW OIL PRESSURE fault is enabled.	
			BEFORE STARTING	The OIL PRESSURE SWITCH and LOW OIL PRESSURE faults are both enabled.	
RADIATOR LEVEL PROBE		NORMAL OPERATION	NORMAL OPERATION	If there is no liquid, the probe switches off the ground signal.	
			REVERSE OPERATION	If there is no liquid, the probe switches on the ground signal.	
ENGINE TEMPERATURE	FUNCTION	EXCLUDED	EXCLUDED	Enables or disables the instrument and its function.	
			INCLUDED		
	TYPE	TTAO/402	See list "ENGINE TRANSDUCERS"	Transmitters already entered.	
	TABLE	25 °C	----	(0 ÷ 3200) ohm	Custom interpolation table which associates the

		50 °C	----		resistance values with the temperature values. Associate at least two values. The fault TEMPERATURE TABLE ERROR will be generated if only one value, or else non-monotonic values, are entered.	
		70 °C	----			
		80 °C	----			
		85 °C	----			
		90 °C	----			
		95 °C	----			
		100 °C	----			
		120 °C	----			
	130 °C	----				
	OVERTEMPERATURE WARNING	FAULT	EXCLUDED	EXCLUDED	See fault.	
THRESHOLD		100 °C	(90–140) °C			
STOP		WITHOUT STOP	WITH STOP WITHOUT STOP			
TX INTERRUPTED	FAULT	INCLUDED	EXCLUDED INCLUDED			
OIL PRESSURE	FUNCTION		EXCLUDED	EXCLUDED INCLUDED	Enables or disables the instrument and its function.	
	TYPE		TPO/403	See list “ENGINE TRANSDUCERS”	Transmitters already entered.	
	TABLE	0 bar	----	0 ÷ 380 ohm		Custom interpolation table which associates the resistance values with the pressure values. Associate at least two values. The fault PRESSURE TABLE ERROR will be generated if only one value, or else non-monotonic values, are entered.
		1 bar	----			
		2 bar	----			
		3 bar	----			
		4 bar	----			
		5 bar	----			
		6 bar	----			
		7 bar	----			
8 bar	----					
9 bar	----					
LOW OIL PRESS. WARN.	FAULT	EXCLUDED	INCLUDED EXCLUDED	See fault.		
	THRESHOLD	0.5 bar	(0 ÷ 6.0) bar			
	DELAY	1 s	(1 ÷ 5) s			
	STOP	WITHOUT STOP	WITH STOP WITHOUT STOP			
FUEL LEVEL	FUNCTION		INCLUDED	EXCLUDED INCLUDED	Enables or disables the instrument and its function.	
	TYPE		VEGLIA	See list “ENGINE TRANSDUCERS”	Transmitters already entered.	
	TABLE	0 %	----	(0 ÷ 380) ohm		Custom interpolation table which associates the resistance values with the fuel percentage values. Associate at least two values. The fault FLOAT TABLE ERROR will be generated if only one value, or else non-monotonic values, are entered.
		10 %	----			
		20 %	----			
		30 %	----			
		40 %	----			
		50 %	----			
		60 %	----			
		70 %	----			
80 %		----				
90 %	----					
100 %	----					
FUEL RESERVE	THRESHOLD	10 %	(0–100)%			
FUEL FINISHED	FAULT	EXCLUDED	INCLUDED EXCLUDED	NO FUEL fault parameters from level.		
	THRESHOLD	1 %	(0–100)%			
	DELAY	3 s	(0 ÷ 60) s			
	STOP	WITH STOP	WITH STOP WITHOUT STOP	NO FUEL fault (level or input) stops or not.		
ALTERNATOR CHARGE	FAULT	STOP	WITHOUT STOP	WITH STOP WITHOUT STOP	Stop enabled or not in the event of fault	
	ALTERNATOR D+	FUNCTION	INCLUDED	INCLUDED EXCLUDED	Includes full management of D+: -fault -engine running	
		THRESHOLD	7 V [12 V] 14 V [24 V]	(3 – 24) [V]	Assessment threshold	
		FAULT	INCLUDED	INCLUDED EXCLUDED	Includes D+ in the charging ALTERNATOR FAULT assessment.	
		ENGINE RUNNING D+	INCLUDED	INCLUDED EXCLUDED	Includes D+ in the engine running assessment.	
		PRE-EXCITATION	INCLUDED	INCLUDED EXCLUDED	Enables alternator pre-excitation.	

ALTERNATOR W	FUNCTION	INCLUDED	INCLUDED	EXCLUDED	Includes full management of W.
	FAULT	INCLUDED	INCLUDED	EXCLUDED	Includes W in the charging alternator fault assessment.
	ENGINE RUNNING W	INCLUDED	INCLUDED	EXCLUDED	Includes W in the engine running assessment and in the RPM displayed.
	CALIBRATION	----	(600 ÷ 5000) RPM		Performs RPM calibration. Provides access to parameter after entering the ENGINE password.
ENGINE RUNNING RP	THRESHOLD	600 RPM	(300 ÷ 4000) RPM		Engine running assessment threshold.
UNDERSPEED	FUNCTION	EXCLUDED	INCLUDED	EXCLUDED	UNDERSPEED fault settings
	THRESHOLD	0 RPM	(0 ÷ 4000) RPM		
	STOP	WITHOUT STOP	WITH STOP	WITHOUT STOP	
OVERSPEED	FUNCTION	EXCLUDED	INCLUDED	EXCLUDED	OVERSPEED fault settings
	THRESHOLD	4000 RPM	(0 ÷ 4000) RPM		
	STOP	WITH STOP	WITH STOP	WITHOUT STOP	
MAXIMUM SPEED		4000 RPM	(0 ÷ 4000) RPM		The maximum RPM value that the engine can reach. When the engine reaches this value, the control unit does not allow the engine rpm to increase any further.
MINIMUM SPEED		800 RPM	(0 ÷ 4000) RPM		Available only for electronic engines. It is the RPM value which is set on engine start-up.
BROWN CABLE		15/54	15/54		Activates during engine start-up.
			ALWAYS ACTIVE		Always active; it turns off only with the control unit in power saving mode.
COOLING TIME		0 s	(0 ÷ 600) s		Once deceleration is complete, the control unit waits for the cooling time before stopping the motor pump. Cooling does not take place if faults have occurred.
HEATING TIME		0 s	(0 ÷ 600) s		Once the diesel engine start-up is completed, the control unit waits for the warm-up period before reaching the working pressure. Protections are active during the warm-up.
COOLING FAN	DELAY	30 s	(0 ÷ 9999) s		Time during which the programmable output COOLING FAN remains active after the motor has stopped.

ENGINE TRANSDUCERS

The control unit has already recorded some values of temperature, pressure and fuel float.

Temperature transmitter tables already entered in the control unit										
TYPE	25°C	50°C	70°C	80°C	85°C	90°C	95°C	100°C	120°C	130°C
TTAO/402	896 ohm	365 ohm	196 ohm	145 ohm	127 ohm	110 ohm	97 ohm	85 ohm	53 ohm	30 ohm
VDO/120	544 ohm	197 ohm	97 ohm	70 ohm	60 ohm	51 ohm	44 ohm	38 ohm	22 ohm	17 ohm
VDO/150	909 ohm	324 ohm	157 ohm	113 ohm	97 ohm	83 ohm	72 ohm	62 ohm	37 ohm	29 ohm
BERU	4036 ohm	1259 ohm	560 ohm	387 ohm	324 ohm	273 ohm	231 ohm	196 ohm	106 ohm	80 ohm
VEGLIA		708 ohm	399 ohm	245 ohm	210 ohm	175 ohm	153 ohm	130 ohm	75 ohm	59 ohm
JCB/1707	503 ohm	200 ohm	105 ohm	78 ohm	67 ohm	59 ohm	51 ohm	45 ohm		9
LOMBARDINI	927 ohm	322 ohm	155 ohm	112 ohm	96 ohm	83 ohm	71 ohm	62 ohm	36 ohm	29 ohm
F16173	2130 ohm	834 ohm	435 ohm	323 ohm	280 ohm	243 ohm	213 ohm	186 ohm	114 ohm	91 ohm
VSG40028	1896 ohm	813 ohm	387 ohm	275 ohm	234 ohm	199 ohm	171 ohm	145 ohm	80 ohm	64 ohm
DUTG	1232 ohm	579 ohm	294 ohm	159 ohm	142 ohm	126 ohm	109 ohm	92 ohm	56 ohm	35 ohm
DAEWOOD	446 ohm	153 ohm	73 ohm	52 ohm	44 ohm	38 ohm	32 ohm	28 ohm	16 ohm	12 ohm
CUSTOM	-	-	-	-	-	-	-	-	-	-

Pressure transmitter tables already entered in the control unit										
TYPE	0BAR	1BAR	2BAR	3BAR	4BAR	5BAR	6BAR	7BAR	8BAR	9BAR
TPO/403	270 ohm	251 ohm	203 ohm	157 ohm	114 ohm	79 ohm	47 ohm	32 ohm	23 ohm	1 ohm
VDO	10 ohm		50 ohm		85 ohm		119 ohm		152 ohm	
VDO 29/10	9 ohm	38 ohm	57 ohm	77 ohm	99 ohm	114 ohm	134 ohm	149 ohm	164 ohm	180 ohm
LOMBARDINI	10 ohm	31 ohm	52 ohm	71 ohm	90 ohm	107 ohm	124 ohm	140 ohm	156 ohm	170 ohm
[10-180] ohm	10 ohm	27 ohm	44 ohm	61 ohm	78 ohm	95 ohm	112 ohm	129 ohm	146 ohm	163 ohm
[240-33.5] ohm	240 ohm	219 ohm	199 ohm	178 ohm	157 ohm	137 ohm	116 ohm	95 ohm	75 ohm	54 ohm
DD6E	7 ohm	39 ohm	72 ohm	104 ohm	132 ohm	159 ohm	187 ohm	215 ohm	242 ohm	270 ohm
VSG40030	259 ohm	215 ohm	172 ohm	139 ohm	106 ohm	83 ohm	60 ohm	46 ohm	32 ohm	21 ohm
CUSTOM	-	-	-	-	-	-	-	-	-	-

Fuel float tables already entered in the control unit		
TYPE	0%	100%
VEGLIA	300 ohm	0 ohm
VDO	10 ohm	181 ohm
DATCON	240 ohm	37 ohm
[10-180] ohm	10 ohm	180 ohm
[240-33.5] ohm	240 ohm	34 ohm
DUMP	5 ohm	90 ohm
EUROSWITCH	3 ohm	184 ohm
CUSTOM	-	-

ENGINE ECU							
Parameter	Variable	Factory settings		Range	Notes		
ENTER PASSWORD	CAN_BUS_PSW	"0000"	"0000" – "9999"	Entering the correct password allows the parameters to be changed.			
CHANGE PASSWORD	CAN_BUS_PSW	"0000"	"0000" – "9999"	Change the password for access to the menu.			
ENGINE TYPE	NO CAN BUS			NO CAN BUS	Conventional mechanical engine		
				SAE J1939 GENERIC	Choice of engine type equipped with control unit for electronic control of the injection system (ECM / ECU).		
				JOHN DEERE			
				PERKINS 110x/220x			
				SCANIA			
				KOHLER			
				DEUTZ EMR2/EMR3			
				FPT NEF/CURSOR			
				VM R756 IE3			
				YANMAR			
				HATZ			
				AIFO			
				JCB DIESELMAX			
				FPT STAGE V			
DOOSAN STAGE V							
DEUTZ STAGE V							
SWITCH-OFF OF INSTR. (only for electronic engines)	FUEL USED	EXCLUDED	INCLUDED		Instruments displayed on the control unit.		
			EXCLUDED				
			INSTANT CONSUMPTION	INCLUDED		INCLUDED	
						EXCLUDED	
			FUEL TEMPERATURE	INCLUDED		INCLUDED	
						EXCLUDED	
			TURBO TEMPERATURE	INCLUDED		INCLUDED	
						EXCLUDED	
			OIL TEMPERATURE	INCLUDED		INCLUDED	
						EXCLUDED	
			INTERCOOLER TEMP.	INCLUDED		INCLUDED	
						EXCLUDED	
			INTAKE TEMP.	INCLUDED		INCLUDED	
						EXCLUDED	
			FUEL PRESSURE	INCLUDED		INCLUDED	
						EXCLUDED	
			COOLANT LEVEL	INCLUDED		INCLUDED	
						EXCLUDED	
			COOLANT PRESSURE	INCLUDED		INCLUDED	
						EXCLUDED	
ENGINE TORQUE	INCLUDED	INCLUDED					
		EXCLUDED					
ENGINE LOAD	INCLUDED	INCLUDED					
		EXCLUDED					
OIL LEVEL	INCLUDED	INCLUDED					
		EXCLUDED					
SOOT LEVEL	INCLUDED	INCLUDED					
		EXCLUDED					
ASH LEVEL	INCLUDED	INCLUDED					
		EXCLUDED					
REAGENT LEVEL	INCLUDED	INCLUDED					
		EXCLUDED					
REAGENT TEMPERATURE	INCLUDED	INCLUDED					
		EXCLUDED					
ADDRESS (only for electronic engines)		1		1 ÷ 100	Control unit source address.		

INJECTION OFF TIME (only for electronic engines)		30 s	(0 ÷ 60) s	Time for which the control unit keeps the injection signal disabled before entering standby (is added to the STANDBY TIME in the menu DEVICE)
ECU OVERTEMPERATURE (only for electronic engines)	FAULT	EXCLUDED	INCLUDED EXCLUDED	See fault Warning overtemperature detected by the ECU
	STOP	WITHOUT STOP	WITH STOP WITHOUT STOP	
FPT S5 PARAMETERS (only for FPT Stage V)	AUTOMATIC REGENERATION	INCLUDED	INCLUDED EXCLUDED	Enables/disables automatic regeneration of the particulate filter
	MANUAL REGENERATION	INCLUDED	INCLUDED EXCLUDED	Enables/disables forced regeneration of the particulate filter
	OIL COUNTERS RESET	INCLUDED	INCLUDED EXCLUDED	Enables/disables option to reset the engine ECU oil quality-related counters.
MANUAL REGENERATION (only for Doosan)		INCLUDED	INCLUDED EXCLUDED	Enables/disables forced regeneration of the particulate filter

IRRIGATION					
Parameter	Variable	Factory settings	Range	Notes	
ENTER PASSWORD		"0000"	"0000" – "9999"	Entering the correct password allows the parameters to be changed.	
CHANGE PASSWORD		"0000"	"0000" – "9999"	Change the password for access to the menu.	
ENGINE RPM MANAGEMENT				Available only for mechanical engines. See Menu.	
PUMP PRIMING				See Menu.	
CLUTCH				See Menu.	
PIPE FILLING				See Menu.	
CONTROL				See Menu.	
PUMP PROTECTION SENSOR		WATER PRESSURE TRANSM.t	WATER PRESSURE TRANSM. PUMP PRESSURE SWITCH	See PUMP PROTECTIONS	
PUMP PRESSURE SWITCH DELAY		5 s	(0 ÷ 9999) s	Cut-in time of the pump pressure switch	
PROTECTION ACTIVATION TIME	MINIMUM	2min	0 to 30 min	See PUMP PROTECTIONS	
	MAXIMUM	10min	0 to 30 min		
	RESTART	10 s	(5 ÷ 600) s		
PROTECTION TYPE		AUTOMATIC ACQUISITION	AUTOMATIC ACQUISITION MANUAL ACQUISITION	Enabled if RPM VARIATION = EXCLUDED	
PUMP WATER UNDERPRESSURE	FUNCTION	INCLUDED	INCLUDED EXCLUDED	The fault 'pump water pressure low' can be disabled.	
	DELAY	5 s	(0 ÷ 9999) s	Intervention time	
	UPPER DIFFERENTIAL	2 BAR	(0,1 ÷ 3,0) BAR	Enabled if PROTECTION TYPE = AUTOMATIC ACQUISITION o ENGINE > RPM VARIATION = INCLUDED	
	LOWER DIFFERENTIAL	1.0 BAR	(0,1 ÷ 3,0) BAR	Enabled if PROTECTION TYPE = MANUAL ACQUISITION and ENGINE > RPM VARIATION = EXCLUDED	
PUMP OVERPRESSURE	WATER	FUNCTION	INCLUDED EXCLUDED	The fault 'pump water pressure high' can be disabled.	
		DELAY	5 s	0 ÷ 9999 s	
		UPPER DIFFERENTIAL	2 BAR	0,1 ÷ 3,0 BAR	Enabled if PROTECTION TYPE = AUTOMATIC ACQUISITION o ENGINE > RPM VARIATION = INCLUDED
		LOWER DIFFERENTIAL	1.0 BAR	0,1 ÷ 3,0 BAR	Enabled if PROTECTION TYPE = MANUAL ACQUISITION and ENGINE > RPM VARIATION = EXCLUDED
		DIFFERENTIAL	26 %	(0–99)%	Enabled if PROTECTION TYPE = MANUAL ACQUISITION and ENGINE > RPM VARIATION = EXCLUDED
MAXIMUM PRESSURE		25.0 BAR	(1,0 ÷ 25,0) BAR	See PUMP PROTECTIONS	
MINIMUM PRESSURE		0.2 BAR	(0 ÷ 1,0) BAR	See PUMP PROTECTIONS	
FILTER WASH	FUNCTION	EXCLUDED	INCLUDED EXCLUDED	See PUMP PROTECTIONS	
	PRESSURE	1 BAR	(0.2 ÷ 21.0) bar		
DISPENSED WATER	FUNCTION	EXCLUDED	INCLUDED EXCLUDED	Enables/disables management of a meter measuring the quantity of water dispensed by the pump. To associate with the input function LITERS COUNTER	
	MODE	LITERS	LITERS COUNTER	See description DISPENSED WATER	

		COUNTER	PRESSURE		
	REFERENCE	SPRINKLER NOZZLE	20mm	CUSTOM	
				10mm	
				...	
				46mm	
		PRESSURE	5,0 BAR	(0,0 ÷ 10,0) BAR	
		WATER FLOW	500 L/MIN	(0 ÷ 3000)L/MIN	
		PRESSURE DROP	0,0 BAR	(0,0 ÷ 10,0) BAR	
		LITERS/PULSE	10 L	(1 ÷ 10000) L	
		RESET		Resets the quantity of water dispensed by the pump	

ENGINE RPM MANAGEMENT				
Parameter	Variable	Factory settings	Range	Notes
RPM VARIATION		INCLUDED	INCLUDED	Management of the engine linear actuator (speed variator) can be excluded. By excluding this function, the "hare" and "tortoise" buttons have no effect and the control unit does not perform the adjustment of the engine rpm. AUTOMATIC IRRIGATION is excluded automatically.
			EXCLUDED	
ACTUATOR PWM		99 %	(0 ÷ 100) %	Actuator PWM
THRUST DIRECTION		NORMAL	NORMAL	Enables selection of the accelerator lever's direction.
			INVERTED	

CONTROL				
Parameter	Variable	Factory settings	Range	Notes
CONTROL MODE		PRESSURE	PRESSURE	See CONTROL MODE section.
			SPEED	
			COMBINED	
SETPOINT RPM	FUNCTION	AUTOMATIC ACQUISITION	AUTOMATIC ACQUISITION	Enabled only if CONTROL MODE = SPEED or COMBINED
	SETPOINT	1500 RPM	(0 ÷ 4000) RPM	
	RPM TOLERANCE	50 RPM	(30 ÷ 300) RPM	
PERMITTED FLUCTUATION		0,2 BAR	(0,0 ÷ 3,0) BAR	Enabled only if CONTROL MODE = PRESSURE or COMBINED
VAR ACTIVATION TIME (mechanical engines)		60 ms	(20 ÷ 2000) ms	See CONTROL MODE section.
VAR PAUSE TIME (mechanical engines)		500 ms	(20 ÷ 2000) ms	
RPM VARIATION STEP (electronic engines)		20 rpm	(5 ÷ 500) rpm	
RPM VARIATION TIME (electronic engines)		60 ms	(20 ÷ 2000) ms	
MAXIMUM ADJUSTMENT TIME	DELAY	120 s	(0 ÷ 999) s	
	FUNCTION	INCLUDED	INCLUDED EXCLUDED	
OPERATING MODE		IRRIGATION	IRRIGATION ANTIFROST	See OPERATING MODE section.
OPERATING POINT RESET		EXCLUDED	INCLUDED EXCLUDED	See CONTROL MODE section.
END OF WORK	FUNCTION	INCLUDED	EXCLUDED	See CONTROL MODE section.
			INCLUDED	
	THRESHOLD	10 %	(1 ÷ 50) %	
ACCELERATION FAULT	DELAY	120 s	(0 ÷ 9999) s	See AUTOMATIC IRRIGATION MODE section.
	FUNCTION	INCLUDED	INCLUDED EXCLUDED	
	THRESHOLD	20 %	(10 ÷ 50) %	
	DELAY	30 s	(0 ÷ 9999) s	

PUMP PRIMING			
Parameter	Factory settings	Range	Notes
PRIMING MODE	EXCLUDED	EXCLUDED	Priming mode
		BEFORE START-UP	
		AFTER START-UP	
		WITH STORAGE TANK	
PRIMING PRESSURE	1 BAR	(0,2 ÷ 3,0) BAR	See section PUMP PRIMING
PRIMING STABILISATION	10 s	(0 ÷ 9999) s	
PRIMING END TIME	0 s	(0 ÷ 9999) s	
PUMP FILLING TIME	20 s	(0 ÷ 9999) s	
PRIMING FAILURE TIME	120 s	(0 ÷ 9999) s	

PIPE FILLING				
Parameter	Variable	Factory settings	Range	Notes
PIPE FILLING MODE		CONSTANT SPEED FILLING	EXCLUDED	Pipe filling mode.
			ACCELERATION FILLING	
			CONSTANT SPEED FILLING	
			FILLING WITH VALVE	
ACTUATOR ACTIVATION (mechanical engines)		60 ms	(20 ÷ 2000) ms	Parameters for ACCELERATION FILLING
ACTUATOR PAUSE (mechanical engines)		500 ms	(20 ÷ 2000) ms	
RPM VARIATION STEP (electronic engines)		20 rpm	(5 ÷ 500) rpm	
RPM VARIATION TIME (electronic engines)		60 ms	(20 ÷ 2000) ms	
FILLING PAUSE		2 s	(0 ÷ 9999) s	
PIPE FILLING FAILURE		120 s	(0 ÷ 9999) s	
FILLING PRESSURE DELTA		0,2 BAR	(0,1 ÷ 3,0) BAR	Parameters for CONSTANT SPEED FILLING
ACTUATOR ACTIVATION (mechanical engines)		60 ms	(20 ÷ 2000) ms	
ACTUATOR PAUSE (mechanical engines)		500 ms	(20 ÷ 2000) ms	
DeltaRPMCanTxt (electronic engines)		20 rpm	(5 ÷ 500) rpm	
RPM VARIATION TIME (electronic engines)		60 ms	(20 ÷ 2000) ms	
PIPE FILLING SPEED		1000 RPM	(300 ÷ 4000) RPM	
FILLING END PRESSURE		3 BAR	(0,2 ÷ 25,0) BAR	Parameters for FILLING WITH VALVE
PIPE FILLING FAILURE		120 s	(0 ÷ 9999) s	
ACTUATOR ACTIVATION		60 ms	(20 ÷ 2000) ms	
ACTUATOR PAUSE		500 ms	(20 ÷ 2000) ms	
PIPE FILLING SPEED		1000 RPM	(300 ÷ 4000) RPM	
VALVE PAUSE		60 ms	(20 ÷ 2000) ms	
VALVE ACTIVATION		500 ms	(20 ÷ 2000) ms	Parameters for FILLING WITH VALVE
FILLING PRESSURE DELTA		0,2 BAR	(0,1 ÷ 3,0) BAR	
FILLING END PRESSURE		3 BAR	(0,2 ÷ 25,0) BAR	
PIPE FILLING FAILURE		120 s	(0 ÷ 9999) s	
VARIATION FAILURE TIME		120 s	(0 ÷ 9999) s	
COMPLETE VALVE ACTIVATION		10 s	(0-30) sec	

CLUTCH				
Parameter	Variable	Factory settings	Range	Notes
FUNCTION		INCLUDED	INCLUDED	Includes or excludes the function CLUTCH.
			EXCLUDED	
INSERTION	THRESHOLD	800 RPM	(300 ÷ 4000) RPM	See CLUTCH
	DELAY	1 s	(0 ÷ 9999) s	
RELEASE	THRESHOLD	700 RPM	(300 ÷ 4000) RPM	
	DELAY	1 s	(0 ÷ 9999) s	

MODEM				
Parameter	Variable	Factory settings	Range	Notes
ENTER PASSWORD		"0000"	"0000" – "9999"	Entering the correct password gives access to the rest of the menu.
CHANGE PASSWORD		"0000"	"0000" – "9999"	Change the password for access to the menu.
MODEM	FUNCTION	INCLUDED	INCLUDED	This parameter is enabled in CEM-196-10 control units. As a general

			EXCLUDED	rule, if the modem module is not installed, it is not possible to enable this function.
IOT	FUNCTION	EXCLUDED	INCLUDED EXCLUDED	If enabled, the control unit can interact with the app.
	APN	“ ”	‘ ’ ÷ ‘z’	APN of the mobile operator, required for app connectivity.
SMS	FUNCTION	INCLUDED	INCLUDED EXCLUDED	If enabled, the control unit can manage SMS text messaging.
	TEXT MESSAGE FROM ALL	INCLUDED	INCLUDED	The control unit will accept SMS commands from all telephone numbers.
			EXCLUDED	The control unit will only accept SMS commands from telephone numbers saved in the directory
	TEXT MSG AT END OF WORK	INCLUDED	INCLUDED EXCLUDED	If enabled, it sends SMS text notifying end of work.
	TEXT MSG START AND STOP	INCLUDED	INCLUDED EXCLUDED	If enabled, it sends SMS text notifying start/stop.
	FUEL FAULT	INCLUDED	INCLUDED EXCLUDED	If enabled, it manages the fuel fault.
	TELEPHONE 1 TELEPHONE 2 TELEPHONE 3 TELEPHONE 4 TELEPHONE 5	“ ”	‘ ’ ÷ ‘g’	Telephone numbers to which text messages will be sent with the GSM modem.

IN-OUT				
Parameter		Factory settings	Range	Notes
ENTER PASSWORD		“0000”	“0000” – “9999”	Entering the correct password gives access to the rest of the menu.
CHANGE PASSWORD		“0000”	“0000” – “9999”	Change the password for access to the menu.
PROGRAMMABLE INPUTS				Menu
4-20mA INPUT				Menu
PROGRAMMABLE OUTPUTS				Menu
RELIEF VALVE	MAXIMUM	12,0 BAR	(0 ÷ 20,0) BAR	See output function RELIEF VALVE
	MINIMUM	5,0 BAR	(0 ÷ 20,0) BAR	
GENERAL ALARM	IMMINENT START	EXCLUDED	INCLUDED	See GENERAL ALARM
			EXCLUDED	
	DURATION	9999 s	0 ÷ 9999 s	See GENERAL ALARM The value 9999 sec indicates operation with no time limit

PROGRAMMABLE INPUTS				
Parameter	Variable	Factory settings	Range	Notes
TYPE		See the table below	FAULT FUNCTION	Identifies whether the input is associated to a function or fault.
FUNCTION (visible if TYPE = FUNCTION)		See the table below	See the full list of functions-input.	Identifies the function associated to the input.
CLOSING DELAY		See the table below	(0 ÷ 9999) s	Delay occurring upon activation.
OPENING DELAY		See the table below	(0 ÷ 9999) s	Delay occurring upon deactivation.
INTERVENTION		See the table below	CLOSED OPEN	The input is active if it is open or closed to common.
STOP (visible if TYPE = FAULT)		See the table below	WITH STOP WITHOUT STOP	Programming enabled if TYPE TYPE = FAULT Sets the moment of activation, storing, the type of alarm and the text for the fault.
DECELERATION (visible if TYPE = FAULT)		See the table below	WITH DECELERATION WITHOUT DECELERATION	
COOLING (visible if TYPE = FAULT)		See the table below	WITH COOLINGt WITHOUT COOLING	
ACTIVATION (visible if TYPE = FAULT)		See the table below	ALWAYS ACTIVE ACTIVE RUNNING	
MEMORY (visible if TYPE = FAULT)		See the table below	NOT STORED STORED	
FAULT TEXT (visible if TYPE = FAULT)		ORANGE/BROWN INPUT FAULT PURPLE/ORANGE WIRE PURPLE INPUT FAULT BLACK/GREEN INPUT FAULT FAULT IN BLACK/BLUE FAULT IN WHITE FAULT IN SKY BLUE FAULT IN ORANGE	‘0’ ÷ ‘9’, ‘,’ ‘A’ ÷ ‘Z’	When the language is changed, the text is reset to the default value.

The factory settings for the inputs are the following:

PROGRAMMABLE INPUTS	TYPE	INPUT SETTINGS							
		CLOSING DELAY	OPENING DELAY	INTERVENTION	STOP	DECELERATION	COOLING	ACTIVATION	MEMORY
IN ORANGE/BROWN	FAULT	5	1	CLOSED	NO	-	-	RUNNING	NO
IN ORANGE/PURPLE	FAULT	2	2	CLOSED	YES	YES	NO	RUNNING	YES
IN PURPLE	PUMP PRESSURE SWITCH	1	1	CLOSED	-	-	-	-	-
IN BLACK/GREEN	CALL	1	1	CLOSED	-	-	-	-	-
BLACK/BLUE INPUT	FUEL PRESSURE SWITCH	1	1	CLOSED	-	-	-	-	-
WHITE INPUT	OIL PRESSURE SWITCH	1	1	CLOSED	-	-	-	-	-
FAULT IN SKY BLUE	ENGINE THERMOSTAT	1	1	CLOSED	-	-	-	-	-
FAULT IN ORANGE	FUEL FINISHED	1	1	CLOSED	-	-	-	-	-

IN 4-20 mA				
Parameter	Variable	Factory settings	Range	Notes
SENSOR		----	----	Type of input sensor connected.
			VACUUM TX	
CALIBRATION	4 mA	-1BAR	(-1 ÷ 10) BAR	Calibration values of the vacuum sensor.
	20 mA	9 BAR	(-1 ÷ 10) BAR	
CAVITATION ALARM	FAULT	INCLUDED	INCLUDED	The vacuum value is below the set threshold and the intervention delay has passed.
			EXCLUDED	
	THRESHOLD	-0.9 BAR	(-1 ÷ 0) BAR	
	DELAY	15 min	(1 ÷ 9999) min	
CAVITATION PRE-ALARM	FAULT	INCLUDED	INCLUDED	The vacuum value is below the set threshold and the intervention delay has passed.
			EXCLUDED	
	THRESHOLD	-0.7 BAR	(-1 ÷ 0) BAR	
	DELAY	15 min	(1 ÷ 9999) min	
EXCESSIVE CAVITATION TIME	FAULT	EXCLUDED	INCLUDED	Fault signalled if the working time of the pump with CAVITATION PRE-ALARM enabled exceeds the set threshold.
			EXCLUDED	
		THRESHOLD	50 h	(0 ÷ 999) h
	RESET HOURS			Resets the pump operating hours with CAVITATION PRE-ALARM active.

PROGRAMMABLE OUTPUTS			
Parameter	Factory settings	Range	Notes
OUTPUT FUNCTIONS	"----	"----	See PROGRAMMABLE OUTPUTS
		WHITE/BLUE WIRE	
		YELLOW/BLUE WIRE	
		YELLOW/WHITE WIRE	
		BROWN/WHITE WIRE	
		BROWN WIRE	
RED/GREEN WIRE			
FAULTS	"----	"----	
		WHITE/BLUE WIRE	
		YELLOW/BLUE WIRE	
		YELLOW/WHITE WIRE	
		BROWN/WHITE WIRE	
		BROWN WIRE	
RED/GREEN WIRE			

For the list of functions, refer to the section PROGRAMMABLE OUTPUTS; for the list of faults, refer to the section FAULTS.

Programming default values are as follows:

Parameter	DEFAULT
GENERAL ALARM	RED/GREEN WIRE
PREHEATING	BROWN/WHITE WIRE
15/54	BROWN WIRE
CLUTCH	YELLOW/WHITE WIRE
PUMP PRIMING	YELLOW/BLUE WIRE
...	"----

SERIAL PORTS					
Parameter	Variable	Factory settings	Range	Notes	
ENTER PASSWORD		"0000"	"0000" - "9999"	Entering the correct password gives access to the rest of the menu.	
CHANGE PASSWORD		"0000"	"0000" - "9999"	Change the password for access to the menu.	
USB-VCP	VCP ADDRESS	1	(1 ÷ 32)	Address of the control unit with MOD Bus RTU Slave protocol.	
	PROTOCOL	MOD BUS	MOD BUS CLI	Data exchange protocol The CLI protocol is active during regular operation whereas in settings mode, MOD BUS is always active .	
RS-485	ADDRESS	1	(1 ÷ 32)	Communication parameters	
	BAUDRATE	9600	(1200 ÷ 115200)		
	SETUP RESET	E,8,1	E,8,1		
			N,8,1		
		O,8,1			
MODEM	BAUDRATE	19200	(1200 ÷ 115200)	Communication parameters	

DEVICE					
Parameter	Variable	Settings setting	Range	Notes	
ENTER PASSWORD		"0000"	"0000" - "9999"	Entering the correct password gives access to the rest of the menu.	
CHANGE PASSWORD		"0000"	"0000" - "9999"	Change the password for access to the menu.	
STAND-BY	FUNCTION		INCLUDED EXCLUDED	Enables or disables the unit's power saving mode or Stand-By.	
	STAND-BY INPUT TIME		30 sec	(1 ÷ 1800) s	This is how long the unit takes to time out to power saving Stand-By mode and turn off.
	STANDBY IF INPUT FAULT		INCLUDED EXCLUDED	INCLUDED EXCLUDED	If enabled, the control unit goes into power saving mode even if a fault is present.
	WAKE UP	IN BLACK/GREEN	DEACTIVATED	DEACTIVATED	See section POWER SAVING.
				OPEN	
		IN ORANGE/BROWN	DEACTIVATED	CLOSED	
DEACTIVATED					
			OPEN		
			CLOSED		
DISPLAY	LCD CONTRAST		50 %	0–100%	Display contrast
	BRIGHTNESS		100 %	0–100%	Display brightness
SETUP RESET				Restore the default settings.	
HOUR METER		0	0h 0' – 1193046h 59'	Engine run time	
FAILED STARTS		0	(0 ÷ 65535)	Number of failed starts	
STARTS		0	(0 ÷ 65535)	Number of engine start-ups	
LIGHT CONTROL		EXCLUDED	INCLUDED EXCLUDED	Enables or disables the spotlight command in the main dashboard.	
UNIT OF MEASUREMENT	TEMPERATURE	°C	°C	Unit of measurement displayed for the TEMPERATURE measurement instruments.	
			°F		
	PRESSURE	bar	bar	Unit of measurement displayed for the PRESSURE measurement instruments.	
			kPa psi		
MANUAL MODE		INCLUDED	INCLUDED EXCLUDED	Makes it possible to exclude the manual mode.	
AUTOMATIC MODE		INCLUDED	INCLUDED EXCLUDED	Makes it possible to exclude the automatic mode.	
OFF MODE		INCLUDED	INCLUDED EXCLUDED	Makes it possible to exclude the off mode.	

HISTORY				
Parameter	Variable	Factory settings	Range	Notes
ENTER PASSWORD		"0000"	"0000" - "9999"	Entering the correct password gives access to the rest of the menu.
CHANGE PASSWORD		"0000"	"0000" - "9999"	Change the password for access to the menu.
HISTORY				Display of event log, always accessible.
DELETE HISTORY				Delete the contents of the log, password access.

MAINTENANCE				
Parameter	Variable	Factory settings	Range	Notes
ENTER PASSWORD		"0000"	"0000" - "9999"	Entering the correct password gives access to the rest of the menu.
CHANGE PASSWORD		"0000"	"0000" - "9999"	Change the password for access to the menu.
MAINTENANCE 1 MAINTENANCE 2 MAINTENANCE 3	MODE	DEACTIVATED	DEACTIVATED	See maintenance.
			MOTOR HOURS	
			RUNNING HOURS	
			CALENDAR	
	EXPIRY	...	DATE MOTOR HOURS RUNNING HOURS Depending on the mode.	Indicates the data regarding the next scheduled maintenance expiry.
	MAINTENANCE TEXT	MAINTENANCE 1 MAINTENANCE 2 MAINTENANCE 3	'0' ÷ '9', 'A' ÷ 'Z'	Text displayed When the language is changed, the text is reset to the default value.
	RESET			Resets the expired maintenance.
START-UP		...	CLOCK/CALENDAR	System commissioning date.

SERVICE (electronic engines only)				
Parameter	Variable	Factory settings	Range	Notes
SERVICE		EXCLUDED	INCLUDED	With the control unit in manual or automatic mode and the engine off, the engine ECU is kept active even when faults that cause the engine to stop occur
			EXCLUDED	

REPLACING THE CONTROL UNIT

Before replacing the control unit, we advise you to transfer all the technical settings to a personal computer and save them in an archive file. This operation can be performed using the ZW-SMART software, which can be requested from Elcos or downloaded from the website www.elcos.it. Hook up the control unit to the computer using the USB port, which can be accessed by removing the control unit's side panel. Make sure to close the side panel back again after use.

TROUBLESHOOTING

FAULT/PROBLEM	LIKELY CAUSES, CORRECTIVE ACTIONS
The control unit is powered but the display is not turning on.	<ul style="list-style-type: none"> • It could be in stand-by. Press the start/stop button. • The cable's red wires must be connected to the battery's positive pole. • The cable's grey wire must be connected to the battery's negative pole. • Check that the battery voltage is higher than 9 V.
The outputs are not actuating properly.	<ul style="list-style-type: none"> • The current absorbed by the loads exceeds the maximum current of the outputs. • Control unit electronics and outputs are protected by the auto-resetting fuses installed in the unit. Do not attempt to replace them.
The control unit turns off during start-up.	<ul style="list-style-type: none"> • Check that the battery voltage is higher than 11 V. • Place a relay between the start-up output and the start-up motor.
The starter motor is working but the engine is not starting.	<ul style="list-style-type: none"> • Out of fuel. Fill up the tank. • Defective fuel supply circuit. • Incorrect stopping system settings (solenoid valve or electromagnet). • Low engine temperature. Check the glow plug preheating efficiency, if any.
Engine stop due to fault.	<ul style="list-style-type: none"> • Read the cause of the stop on the display and act accordingly.
The engine is not stopping in any way.	<ul style="list-style-type: none"> • Ensure the stopping system is working properly, both electrically and mechanically (solenoid valve or electromagnet). • If the stopping system is fitted with electromagnet, place a relay between the stopping output and the electromagnet.
The account is correct on the app but it is not accepting the serial number or the access code.	<ul style="list-style-type: none"> • Before connecting the app to the control unit, you must follow the steps described in the "Elcos Smart Control" manual in the order shown.
The control unit is not connecting to the app.	<ul style="list-style-type: none"> • The first connection to the control unit must be done on site. • Insert the SIM card. • Set the correct APN for the mobile operator. • The SIM card should be enabled for data traffic. • 900 MB of data traffic per month should not be exceeded, not even when operating full-time. • The telephone signal is too weak.
The control unit is not sending or receiving SMS text messages.	<ul style="list-style-type: none"> • The SIM card should be enabled for SMS text messaging. • The SMS recipient's telephone number was not stored. • The telephone signal is too weak.
Forgot the account password.	<ul style="list-style-type: none"> • In the login page, press FORGOT PASSWORD; follow the procedure to receive an email with a new password.
The control unit signals a problem with the phone every 30 seconds.	<ul style="list-style-type: none"> • Wrong APN. • The telephone signal is too weak.

TECHNICAL SPECIFICATIONS

POWER SUPPLY						
Suitable for batteries				12 Vdc	24 Vdc	
Operating range	<i>Identifier</i>	<i>Terminal</i>	<i>Colour</i>	(8 ÷ 48) Vdc		
	+BATT	CONN A-A8; CONN A-B8	RED			
	-BATT	CONN A-C8	GREY			
Absorption with engine not running *1)		CEM-190	130 mA @12 Vdc		90 mA @24 Vdc	
		CEM-196	145 mA @12 Vdc		100 mA @24 Vdc	
Absorption in Stand-By *1)				Approx. 12mA	Approx. 10mA	
Voltage dip on battery power supply				From 10Vdc to 0Vdc for 150ms		
STATIC-TYPE CLOSED OUTPUTS ON +BATT						
<i>Identifier</i>	<i>Terminal</i>	<i>Colour</i>		<i>Maximum load</i>		
GLOW PLUGS	CONN A-C1	WHITE/BROWN		0.5 A		
GENERAL ALARM	CONN A-A3	RED/GREEN		0.5 A		
15/54	CONN A-A5	BROWN		0.5 A		
Programmable	CONN B-C2	YELLOW/BLUE		0.5 A		
Programmable	CONN B-C3	YELLOW/WHITE		0.5 A		
Programmable	CONN B-A8	WHITE/BLUE		0.5 A		
VAR	CONN B-A1; CONN B-B1	GREEN and YELLOW		3 A		
VALVE	CONN B-B8; CONN B-C8;	BROWN/GREEN e BROWN/RED		3 A		
RELAY-TYPE CLOSED OUTPUTS ON E-POWER						
<i>Identifier</i>	<i>Terminal</i>	<i>Colour</i>		<i>Maximum load</i>		
STOP	CONN A-A6	YELLOW		3A (2A@65°C)		
RELAY-TYPE CLOSED OUTPUTS ON +BATT						
<i>Identifier</i>	<i>Terminal</i>	<i>Colour</i>		<i>Maximum load</i>		
STARTING	CONN A-A1; CONN A-B1 (Use both)	BLACK		20 A @12V	10 A @24V	
ANALOGUE INPUTS						
<i>Identifier</i>	<i>Terminal</i>	<i>Colour</i>	<i>Input</i>	<i>Accuracy</i>	<i>Measurement range</i>	
FUEL FLOAT	CONN A-C4	ORANGE/BLUE	(0 ÷ 380) Ω	±2% *1)	(0 ÷ 100) %	
ENGINE TEMPERATURE TX	CONN A-C3	WHITE/PURPLE	(0 ÷ 3200) Ω	±2% *1)	(0 ÷ 140) °C	
OIL PRESSURE TX	CONN A-C2	WHITE/GREEN	(0 ÷ 380) Ω	±2% *1)	(0,0 ÷ 9,0) BAR	
FREQUENCY OUTPUTS						
<i>Identifier</i>	<i>Terminal</i>	<i>Colour</i>	<i>Measurement range</i>		<i>Measurement range</i>	
ALTERNATOR W	CONN A-A4	WHITE/RED	(0,75 ÷ 65) Vac		(50 ÷ 2000) Hz	
VOLTAGE INPUTS						
<i>Identifier</i>	<i>Terminal</i>	<i>Colour</i>	<i>Measurement range</i>			
ALTERNATOR D+	CONN A-B4	GREEN	(0.5 ÷ 30) Vdc			
DIGITAL INPUTS (CLOSED TO NEGATIVE)						
<i>Identifier</i>	<i>Terminal</i>	<i>Colour</i>	<i>Threshold H</i>	<i>Threshold L</i>	<i>Max. current supplied</i>	
OIL PRESSURE SWITCH	CONN A-B2	WHITE	> 2V	≤ 0.8V	3.3 mA @ 48 V	
ENGINE THERMOSTAT	CONN A-B6	BLUE				
FLOAT SWITCH CONTACT	CONN A-B7	ORANGE				
Programmable (def. FAULT)	CONN A-C6	ORANGE/BROWN				
Programmable (def. FAULT)	CONN A-C7	ORANGE/PURPLE				
Programmable (def. CALL)	CONN B-A5	BLACK/GREEN				
Programmable (def. PUMP PRESSURE SWITCH)	CONN B-C4	PURPLE				
Programmable (def. FUEL PRESSURE SWITCH)	CONN A-B3	BLACK/BLUE				
EMERGENCY BUTTON						
<i>Identifier</i>	<i>Terminal</i>	<i>Colour</i>	<i>Characteristics</i>			
E-V_BATT	CONN A-A2	BROWN	Battery positive			
E-POWER	CONN A-A7	BLUE	STOP output supply			
E-IN	CONN A-B5	YELLOW/GREEN	Digital input			
			<i>Threshold H</i>	<i>Threshold L</i>	<i>Max. absorbed current</i>	
			> 2V	≤ 2V	4 mA @ 48 V	
LINES OF COMMUNICATION						
USB 2.0 (USB-B connector)	Inside control unit		Not isolated. Maximum cable length 3 m.			
RS-485	CONN B-B2	WHITE	A	Not isolated.		
	CONN B-B3	BROWN	B			
ENVIRONMENTAL CONDITIONS						
Operating temperature			(-20 ÷ 60) °C			
Storage temperature			(-20 ÷ 60) °C			
Relative humidity			≤ 80%			
PROTECTION CLASS						
IP			IP 55			
CONTAINER						
Weight			1.25kg			
Dimensions (LxHxD)			Only container: (207 x 183 x 135) mm. With fastening brackets: (215 x 196 x 135) mm			
Wiring length			2.80 m			
Material			PC-ABS V0 and front panel in metal			
MEASUREMENT INPUTS						
<i>Identifier</i>	<i>Terminal</i>	<i>Colour</i>	<i>Characteristics</i>			
TPA	CONN B-A2	GREEN	GROUND			
	CONN B-A3	BROWN	+5 Vdc			
	CONN B-A4	WHITE	Voltage input (0 - 5) VDC			

VACUUM SENSOR	CONN B-B4	WHITE/BLACK	POWER OUT: BATTERY VOLTAGE
	CONN B-B5	BLUE/GREY	IN: 4-20mA, Rin = 240Ω, Vinmax=5Vdc
VIBRATIONS AND SHOCKS			
<i>Identifier</i>	<i>Regulations</i>		<i>Characteristics</i>
Sine Vibration Test	EN 60068-2-6:2008		0,70 mm p-p from 10 Hz to 59,55 Hz 5g from 59,55 Hz to 500 Hz
Shock Test	EN 60068-2-27:2009		Peak acceleration 25g, pulse duration 6mS Peak acceleration 10g, pulse duration 11mS

*1) approximate value

MECHANICAL DIMENSIONS

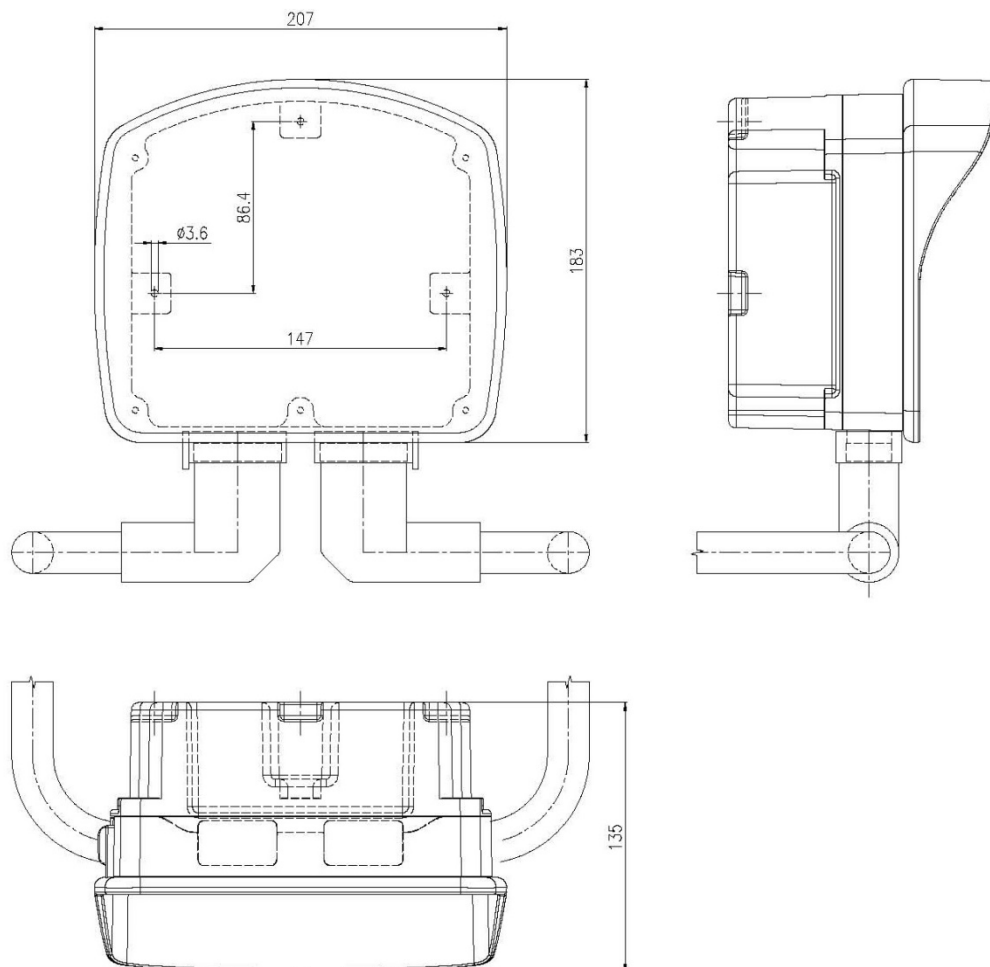

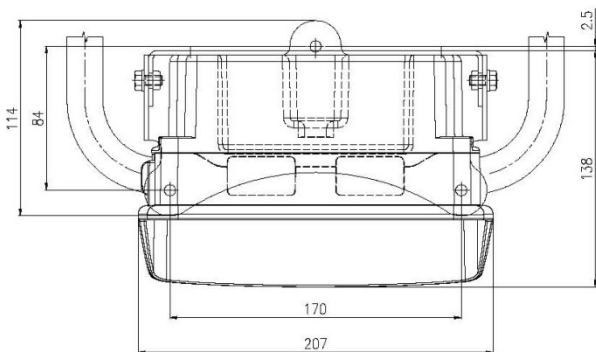
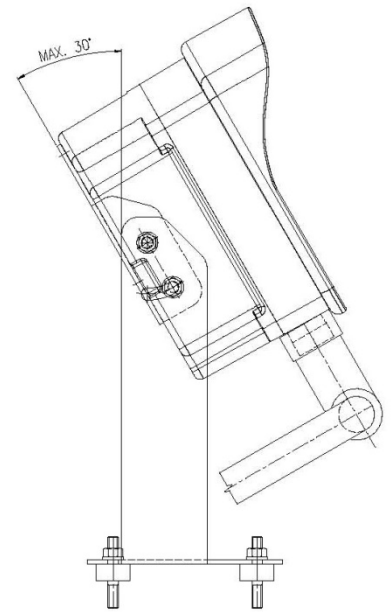
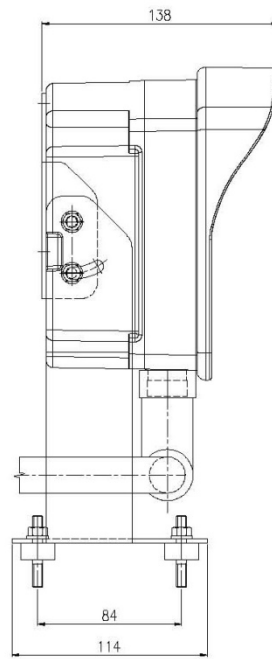
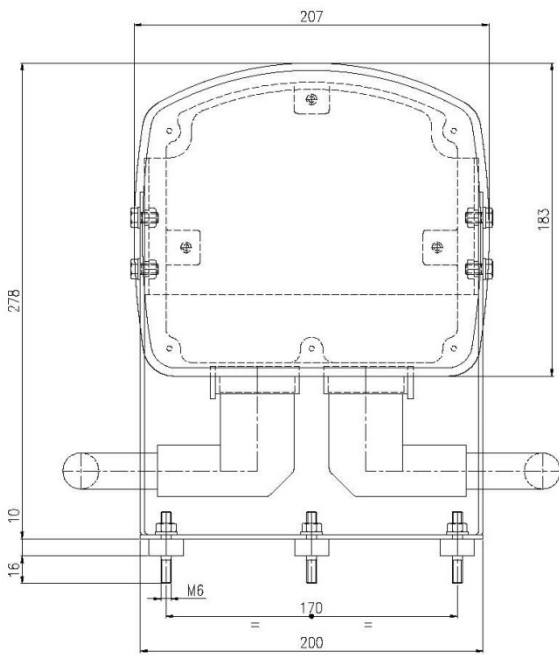
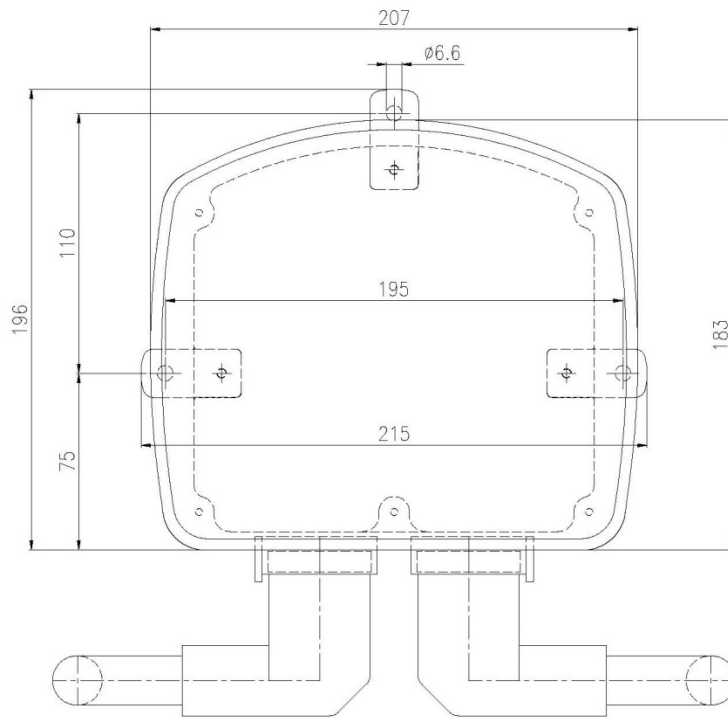

INSERTING THE SIM CARD CEM-196-10



WARNING

It only controls and commands a diesel-engine driven irrigation pump. Commands the stop if a fault to probe-controlled parts occurs. It is also designed for installation on board the machine.

Warning: Compliance with the following recommendations is obligatory



- Always make connections following the wiring diagram provided in the manual.
- Non rimuovere mai il coperchio posteriore dalla centralina, decadrebbe la protezione IP.
- All works performed on the unit must be carried out with the engine off and with starter motor terminal 50 disconnected.
- Check the consumption of the connected devices is in line with the described technical specifications.
- The installation must always guarantee adequate dissipation of heat.
- Always install the device at a lower position than any other devices that produce or dissipate heat.
- Handle and connect without exposing the electronic circuit board to mechanical strain.
- Do not let cuttings of copper conductors or other metal residues drop onto the control unit.
- Never disconnect the battery terminals while the engine is running.
- Strictly avoid using a battery charger for emergency start-up; this could damage the control unit.
- To safeguard persons and equipment, always disconnect the electrical system terminals from the battery poles before connecting an external battery charger.

Device sensitive to electrostatic discharge

Do not open the container unless precautions to avoid electrostatic discharges have been taken.



This control unit is not suitable for operation under the following conditions:



- Where the room temperatures exceeds the limits specified in the technical data sheet.
- Where abrupt shifts in temperature and air pressure produce exceptional condensation.
- Where there is high pollution caused by dust, fumes, vapour, salts and corrosive or radioactive particles.
- There is high radiation of heat due to direct sunlight, ovens or the like.
- You suspect the presence of mould or pests.
- There is a danger of fire or explosion.
- Strong shocks or vibrations can be transmitted to the control unit.

Electromagnetic Compatibility

This control unit works correctly only if it is installed in systems that comply with regulations governing CE marking; in fact, it complies with the immunity requirements given in EN61326-1, but this does not rule out the possibility that malfunctions could occur in extreme cases that may arise in particular situations.

The installer is responsible for checking that the level of perturbation does not exceed that specified in standards.

Operation and maintenance

We recommend the following maintenance on a weekly basis:



- checking the signals;
- checking the battery status;
- checking the wires are connected firmly and the condition of the terminals.

INFORMATION FOR ORDERING

Type	Item Code
CEM-190-10	00210744
CEM-196-10	00210745
CEM-190EM	00210742
CEM-196EM	00210743

STANDARD ACCESSORIES

Type	Item Code
CEM-190-10 ENGINE PRE-WIRED FEMALE CONNECTOR	70804466
PREWIRED FEMALE CONNECTOR CEM-190-10 TPA-200	70804467
CABLE FOR TPA-200 CEM-190	40500262
TPA-200 PUMP WATER PRESSURE TRANSMITTER	70500255
REDUCING NIPPLE F1/4" GAS – M3/8" GAS	70190241
ZANCHE CEP/CEM KIT	40804362
MAGNETIC ANTENNA WITH 3m cable (ONLY FOR CEM-196-10)	70070187
SUPERSEAL 2-POLE CONNECTOR KIT	40804602

ACCESSORIES AVAILABLE ON REQUEST

Type		Item Code
AST-015/00	Rod electrode, including accessories	40241012
E-25	Screw electrodes, including accessories	40190115
VAR-140 12V	Linear actuators	00571543
VAR-144 24V	Linear actuators	00571551
CRU-1901	Base assembly support	40493385
ZW-SMART	Programming software	00070212

ON-LINE LITERATURE

Downloadable from the website www.elcos.it/



CONFORMITY
CE